

MagicStream™ Deck Jet II Installation Instructions

Kit (P/N 580003) Contents

- Deck Jet Body — (Qty 4)
- Nozzle Kit (P/N 590041) — (Qty 4)
- Deck Jet Cover (P/N 990042) — (Qty 4)

Note: Each kit contains parts for four (4) MagicStream Deck Jet II units.



WARNING — FOR YOUR SAFETY: This product must be installed and serviced by a professional pool/spa service technician. The procedures in this manual must be followed exactly. Improper installation and/or operation will void the warranty.

This document gives instructions for installing the Pentair MagicStream Deck Jet II. Read through the instructions completely before starting the procedure..

Technical support

Sanford, North Carolina (8 A.M. to 5 P.M. - ET)

Moorpark, California (8 A.M. to 5 P.M. - PT)

Phone: (800) 831-7133

Fax: (800) 284-4151

Web sites: www.pentairpool.com - www.staritepool.com

590043 (Rev A) 2/1/2008

Overview

The MagicStream Deck Jet II is designed to be installed in the deck or landscaping surrounding the pool, spa, fountain, or pond. The Deck Jet's swivel nozzle (Figure 1) produces a 5/16" stream of water. The Deck Jet body is equipped with two, 3/16" drain holes to allow water to drain from the cup surrounding the nozzle into the drain cavity at the base of the body (Figure 1). Be sure to keep the drain holes clear of debris. To aid in draining, Pentair recommends placing a gravel layer beneath the Deck Jet.

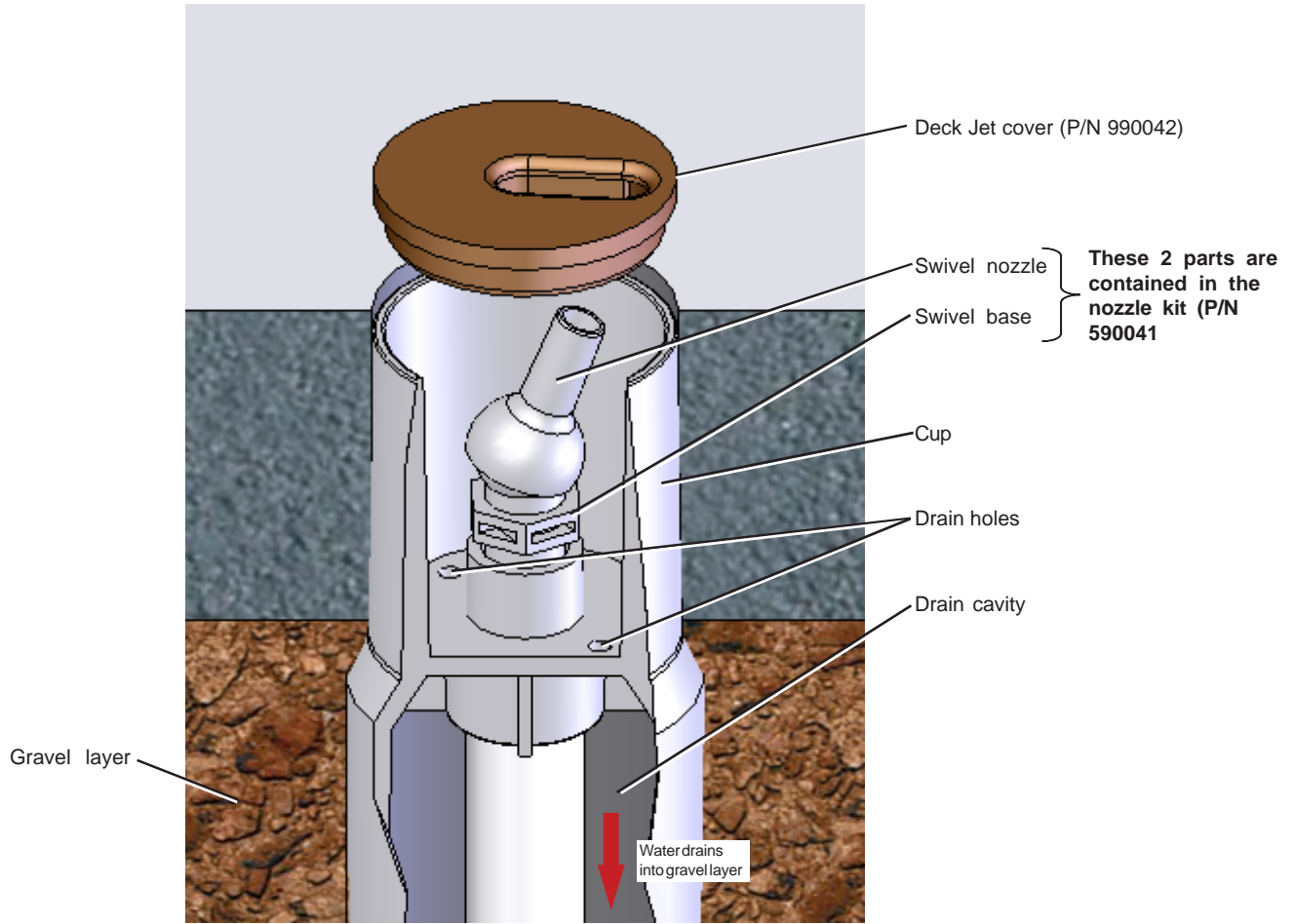

Figure 1

Pentair recommends that each Deck Jet be fitted with a 3/4" ball valve to allow flow control for each nozzle. For installations involving multiple nozzles, we recommend installing a 3-way valve on the main line near the pump for overall adjustment.

The Deck Jet is designed for a maximum flow rate of 5GPM at 11 ft of head (See table below).

Water/Pressure Specifications

Gallons (US GPM)	3.0	4.0	5.0
Feet of head	3.9	7.9	11.0
Height of jet	3.0	6.6	10.0

Installation

The Deck Jet body is designed to be connected to a 3/4" Sch40 PVC pipe (Figure 2). After the pipe is pressure tested, solvent weld the Deck Jet body to the 3/4" supply pipe. **NOTE: Use PVC/ABS glue only.** Anchor the Deck Jet body, with the Deck Jet cover attached, so the cover is level with the finished deck surface.

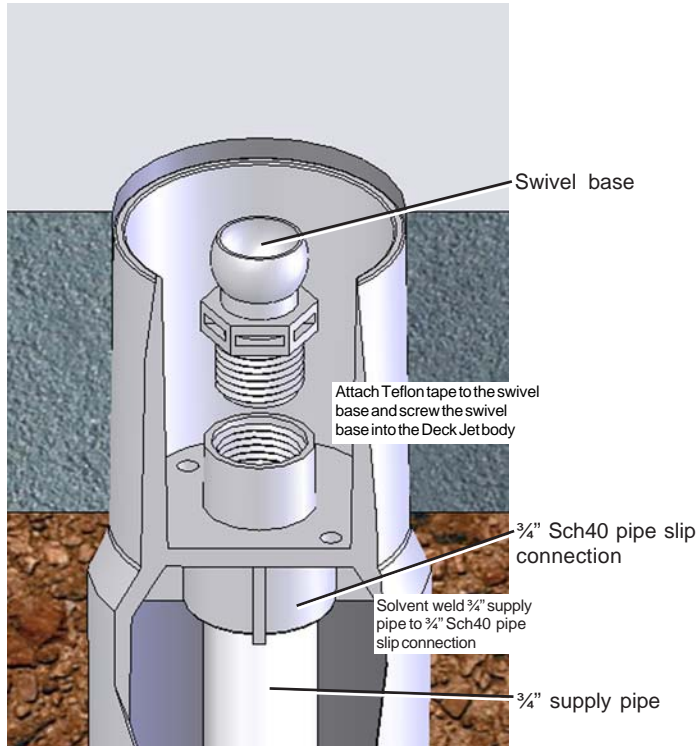

Figure 2

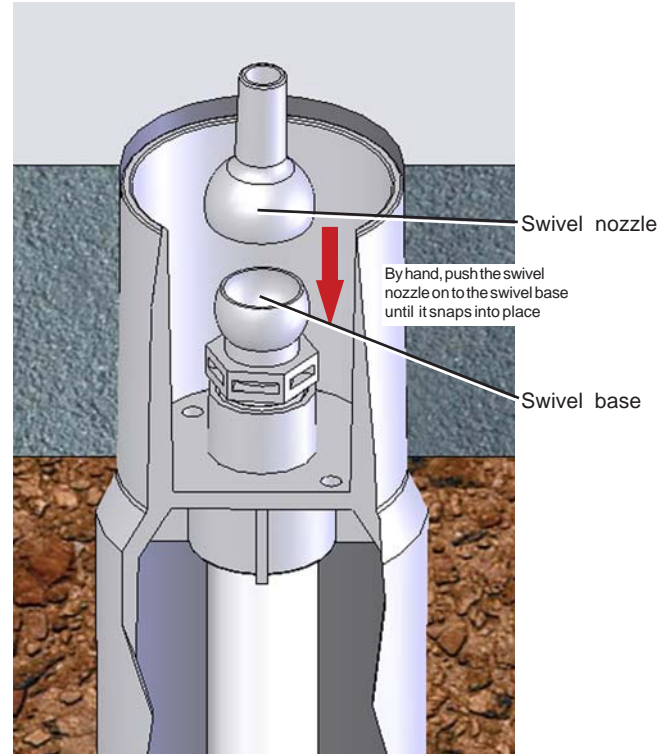

Figure 3

Once the deck is finished, flush any debris from the supply pipe using the pump and filter system that supplies the Deck Jet. Apply Teflon[®] tape to the threads of the swivel base. Remove any debris from the cup and screw the swivel base into the Deck Jet body (Figure 2).

By hand, push the swivel nozzle until it snaps onto the swivel base (Figure 3).

Operation

Start the pump and adjust the appropriate valves as necessary to create the desired water effect.

If the stream of water is disrupted, remove the Deck Jet Cover, Jet and Jet Swivel Base. Check to see if there is any debris blocking the Jet.

To winterize, remove the Jet and Jet Swivel Base. Blow the lines clear with air, and install a 1/2" threaded plug.



© 2008 Pentair Water Pool and Spa, Inc. All rights reserved.

This document is subject to change without notice.

1620 Hawkins Ave., Sanford, NC 27330 • (919) 566-8000

10951 West Los Angeles Ave., Moorpark, CA 93021 • (805) 553-5000

Trademarks and Disclaimers:

MagicStream™ and Pentair Water Pool and Spa® are trademarks and/or registered trademarks of Pentair Water Pool and Spa, Inc. and/or its affiliated companies in the United States and/or other countries. Teflon® is a registered trademark of E.I. Du Pont De Nemours and Company Corporation. Unless noted, names and brands of others that may be used in this document are not used to indicate an affiliation or endorsement between the proprietors of these names and brands and Pentair Water Pool and Spa, Inc. Those names and brands may be the trademarks or registered trademarks of those parties or others.

Printed in U.S.A.

590043 (Rev A)