

# Hayward ECOMMAND



## Automation



## Installation Manual

# **IMPORTANT SAFETY INSTRUCTIONS**

When using this electrical equipment, basic safety precautions should always be followed, including the following:

- **READ AND FOLLOW ALL INSTRUCTIONS**
-  **WARNING: Disconnect all AC power during installation.**
-  **WARNING: Water in excess of 100 degrees Fahrenheit may be hazardous to your health.**
-  **WARNING: To reduce the risk of injury, do not permit children to use this product unless they are closely supervised at all times.**
- A green colored terminal marked “Earth Ground” is located inside the wiring compartment. To reduce the risk of electric shock, this terminal must be connected to the grounding means provided in the electric supply service panel with a continuous copper wire equivalent in size to the circuit conductors supplying the equipment.
- One bonding lug for US models (two for Canadian models) is provided on the external surface. To reduce the risk of electric shock, connect the local common bonding grid in the area of the swimming pool, spa, or hot tub to these terminals with an insulated or bare copper conductor not smaller than 8 AWG US / 6 AWG Canada.
- All field installed metal components such as rails, ladders, drains, or other similar hardware within 3 meters of the pool, spa or hot tub shall be bonded to the equipment grounding bus with copper conductors not smaller than 8 AWG US / 6 AWG Canada.
- **SAVE THESE INSTRUCTIONS**

# Table of Contents

<b>Introduction</b>	Before You Begin.....	1
	Installation Steps.....	2
<b>1. Mounting Equipment</b>	ECOMMAND Control Center.....	3
	Temperature Sensors.....	3
	Optional Wireless Remote Control.....	3
	Optional Valve Actuators.....	4
<b>2. Plumbing</b>	Plumbing Configuration.....	4
<b>3. Electrical Wiring</b>	Main Service.....	6
	Grounding and Bonding.....	6
	Circuit Breaker Installation and Wiring.....	6
	General Purpose Outlet.....	6
	ECOMMAND Control Power.....	6
	High Voltage Pool Equipment.....	7
	Low Voltage Wiring.....	8
<b>4. Configuration</b>	Configuration Menu.....	13
<b>5. System Startup and Checkout</b>	Before Startup.....	20
	Heater Checkout.....	20
	Service Mode.....	21
<b>7. Warranty</b>	ECOMMAND Limited Warranty.....	24

# Introduction

## **Before You Begin**

### ***What's Included***

Before attempting to install the ECOMMANT system, check that the following components have been included in the package:

#### *ECOMMAND Electronics Unit*

(2) Temperature sensors with 15 ft. (5m) cable, hose clamp

### ***What's NOT Included***

Some of the additional items that you may need to complete an installation include:

#### *Circuit breakers*

None are included with control—see page 6 and inside of door for suitable breakers

#### *Wire*

Wire/conduit for 100A service from main panel to ECOMMANT

Wire/conduit for filter pump and other high voltage loads

Wire for bonding

#### *Miscellaneous*

Utility electrical outlet and weatherproof cover (for mounting on side of ECOMMANT)

Mounting hardware (screws, etc.) for mounting ECOMMANT and remote display/keypad

Valves (use standard Hayward, Pentair/Compool, or Jandy valves)

Additional valve actuators

## ***Accessory Products - Order Separately***

HPC-RF-KIT	Remote Control with required Base Station
GLX-RF-3B	Replacement Remote Control for HPC-RF-KIT only
GLX-BASE-RF	Replacement Base Station for HPC-RF-KIT
AQL-DIM	Light Dimmer Relay
AQL-DC	Light Hub
AQL-RELAY-AC-KT	AC Relay Kit (connect valve output to high voltage relay output)
AQL-RELAY-DC-KT	DC Relay Kit (connect aux1 output to high voltage relay output)
V&A-xx	Valve & Actuator (xx=1P (1.5" pos. seal), -2P (2" pos. seal))
GVA-24	Valve Actuator

## Installation Steps

Details on each installation step are presented on the following pages:

1. Mounting the equipment (page 3)
  - ECOMMAND main unit
  - Temperature sensors
  - Valve actuator (if applicable)
2. Plumbing (page 4)
  - General Pool Equipment
3. Electrical Wiring (page 6)
  - Main service
  - Grounding and bonding
  - Circuit breakers
  - ECOMMAND control power
  - High Voltage pool equipment
  - Low voltage wiring (temperature sensors, flow switch, etc.)
4. ECOMMAND control configuration (page 13)
5. System Startup and checkout (page 20)

# **1. Mounting the Equipment**

## **ECOMMAND Control Center**

The ECOMMAND is contained in a raintight enclosure that is suitable for outdoor mounting. The control must be mounted a minimum of 5 ft. (2 meters) horizontal distance from the pool/spa (or more, if local codes require). The Control Center is designed to mount vertically on a flat surface with the knockouts facing downward. Because the enclosure also acts as a heat sink (disperses heat from inside the box), it is important not to block the four sides of the control. Do not mount the ECOMMAND inside a panel or tightly enclosed area.

When selecting a location, note that the standard cables supplied with the temperature sensors, and valve actuator (if applicable) are all 15 ft. (5m) long.

## **Temperature Sensors**

Two sensors are included with the ECOMMAND. A water sensor and an air sensor must be installed at all times for proper operation. An optional solar sensor is required if the solar function is enabled.

### **Water Sensor**

This sensor is used to measure the pool/spa temperature and is installed in the filtration plumbing after the filter but before either the solar or conventionally fueled heaters—refer to the plumbing overview diagram.

1. Drill a 3/8” (10mm) diameter hole in the PVC piping and remove all chips and burrs.
2. Insert sensor until O-ring collar sits flush on the hole.
3. Position hose clamp over the sensor and gently tighten until O-ring makes an adequate seal. Do not overtighten.
4. For maximum temperature accuracy, cover the sensor and 3” (6cm) of pipe on either side with insulation and white paint.

### **Air Sensor**

Mount the air sensor outdoors.  **IMPORTANT: Mount the air sensor out of direct sunlight.**

### **Solar Sensor**

For solar applications, mount the sensor near the solar collector array so that it is exposed to the same sunlight as the collectors. Use additional cable (20 AWG) if necessary.

## **Optional Wireless Remote Control Kit (HPC-RF-KIT)**

Hayward offers a wireless remote control kit (HPC-RF-KIT) for the ECOMMAND control. A base station (AQL2-BASE-RF) and 3 button wireless remote control (GLX-RF-3B) are included in this kit. The maximum distance between the wireless remote and the base station on the ECOMMAND main control unit is 400 feet (120m) line of sight or 200 feet (60m) through walls, etc.

### **Installing the AQL2-BASE-RF Base Station**

This optional base station must be installed if the wireless remote (GLX-RF-3B) is used. To install the base station, remove the knockout on the upper left side of the ECOMMAND main control unit, insert the base station, and then tighten the nut from the inside. For wiring instructions, refer to page 12.

The wireless remote control kit requires the user to run the “Teach Wireless” routine in the Settings Menu. This information can be found in the ECOMMAND Operation Manual.

## Optional AQL-RELAY-DC-KT Relay Kit

The AQL-RELAY-DC-KT can be used to provide an additional high voltage auxiliary output. This relay mounts beside the FILTER and LIGHTS relays (see page 5) and plugs into the Aux 1 output connector located on the ECOMMANT PCB board (also shown on page 5). This relay is controlled by the Aux 1 function. Refer to the Configuration and the Settings sections of the Operation Manual for information on how the Aux 1 output operates.

## Optional Valve Actuator

If using an optional actuator, note that the internal cams in the actuator may have to be adjusted depending on the way the actuator is mounted on the valve and the desired valve action.

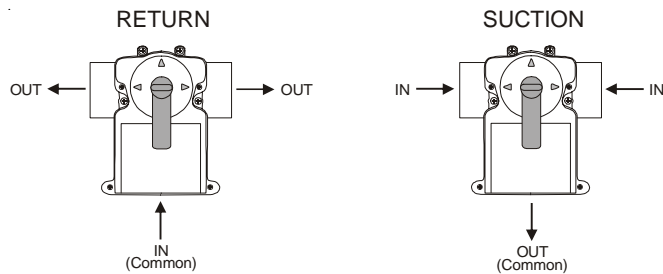

# 2. Plumbing

## Plumbing Configuration

The ECOMMANT can be used to control a variety of different pool equipment. Refer to the diagram below for possible plumbing configurations. Note that each output can only control one piece of equipment.

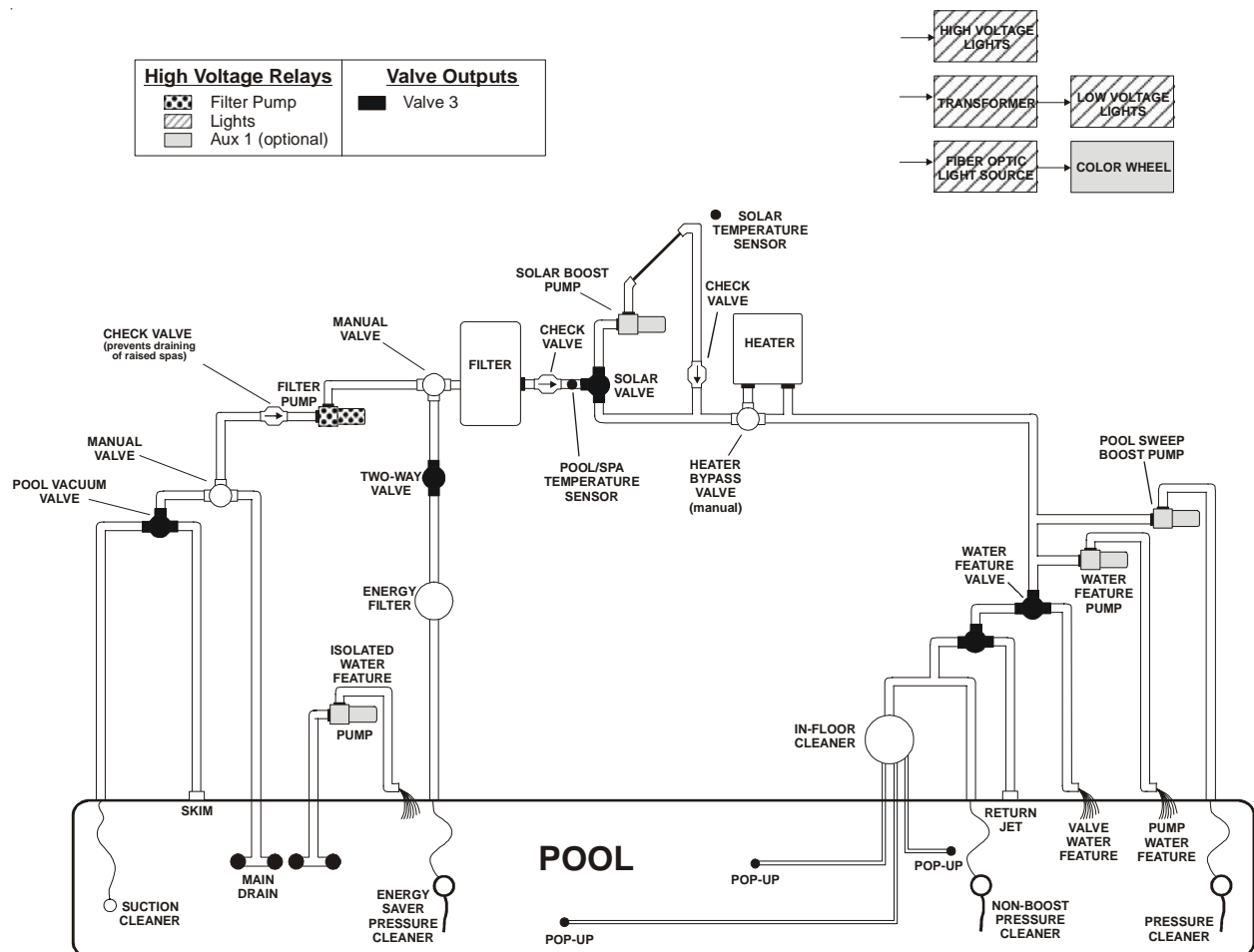

1. A conventional heater (gas or heat pump) and solar can be used to heat both the pool or the spa.
2. The water sensor should be installed prior to any heater or solar and will display the water temperature. The temperature will only be displayed when the filter pump is running.
3. If any water feature or pressure side cleaner boost pumps are used, be sure to enable the “interlock” feature (see “Configuration Menu” for details) to ensure that the pumps operate only when the filter pump is on.
4. The plumbing diagram is intended to be used as a general guideline and is not a complete plumbing schematic for the pool.
5. The air sensor must be installed if the freeze protection feature is enabled for the filter, valve or aux outputs.

### **3. Electrical Wiring**

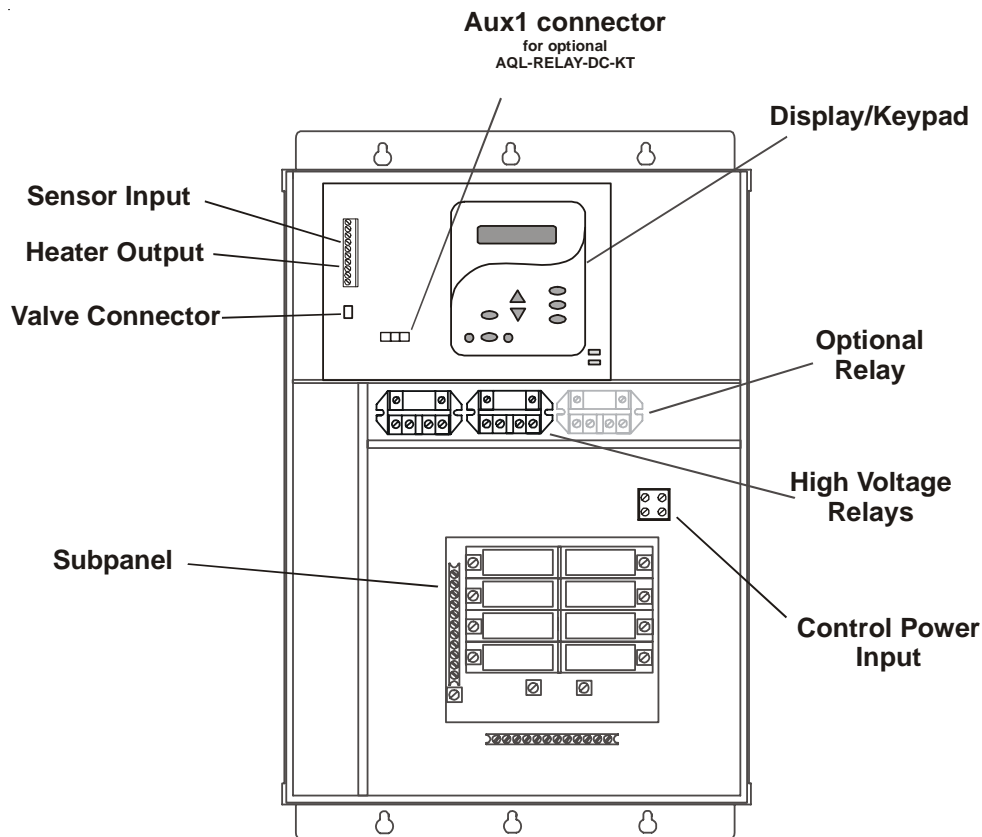

The ECOMMANT Control Center requires both high and low voltage connections. Low voltage connections may be made to an optional actuator, heater and sensors.. High voltage connections will be made to pumps, lights, and other desired pool equipment, as well as providing direct input power to the Control Center. Always:

- Ensure that power is disconnected prior to doing any wiring
- Follow all local and NEC (CEC if applicable) codes
- Use copper conductors only



## Main Service (Power to the Circuit Breaker Subpanel)

The ECOMMANT circuit breaker subpanel is rated for 100A service. Run properly rated conductors (L1, L2, N, and ground) from the primary house electrical panel to the main power connections on the ECOMMANT circuit breaker base. The connection at the main house panel should be to a 240VAC circuit breaker rated at 100A maximum.

## Grounding and Bonding

Connect a ground wire from the primary electrical panel to the ECOMMANT ground bus bar. Also ground each piece of high voltage (120 or 240VAC) equipment that is connected to the ECOMMANT control relays or circuit breakers. The ECOMMANT should also be connected to the pool bonding system by an 8AWG (6AWG for Canada) wire. A lug for bonding (2 for Canada) is provided on the outside/bottom of the ECOMMANT enclosure.

## Circuit Breaker Installation and Wiring

Circuit breakers are to be supplied by the installer. Refer to the circuit breaker chart below for a list of suitable circuit breakers that can be used. Follow the code and the circuit breaker manufacturer's rating requirements regarding the size and temperature rating for wiring. Note that some pool equipment may be required to be connected to ground fault circuit breakers—check local and NEC (CEC) codes.

SUITABLE LISTED BREAKERS						
Manufacturer	Single	Double	Twin	Quad	GFCB	Filler Plates
Cutler-Hammer	BR	BR	BRD	BRD	GFCB	BRFP
Murray	MP-T	MP-T	MH-T	MH-T	MP-GT	LX100FP
Siemens	QP	QP	QT	QT	QPF	QF3
Square D	HOM	HOM	HOMT	HOMT	HOM	HOMFP
Thomas & Betts	TB	TB	TBBD	TBBQ	GFB	FP-1C-TB

## General Purpose Outlet

If desired, a duplex receptacle with weatherproof cover (supplied by installer) may be installed in the knockouts on the lower right side of the ECOMMANT enclosure. Per code, the receptacle should be a GFCI type. Alternatively, connect a standard receptacle to a GFCB.

## ECOMMAND Control Power

The ECOMMANT requires 120VAC, 2A power to operate the control logic circuits. This power should be connected to one of the circuit breakers.

**⚠ WARNING: 120VAC only (permanent damage if connected to 240V)**

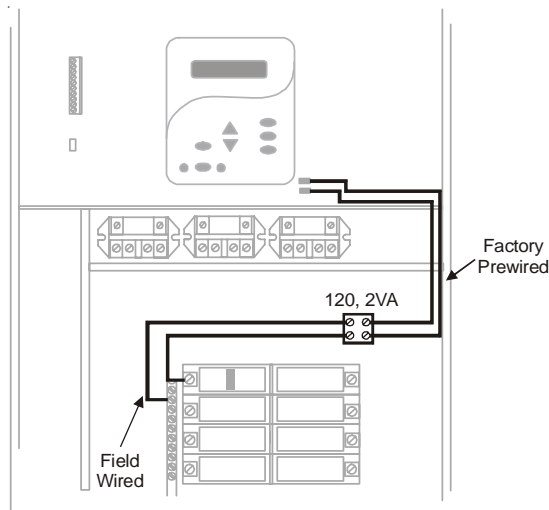

## High Voltage (120/240V) Pool Equipment

All ECOMMAND relays are double pole (they make/break both “legs” of 240V circuits) and are rated at 3HP/30A at 240V (1½HP/30A at 120V). Refer to the diagram below for typical relay wiring.

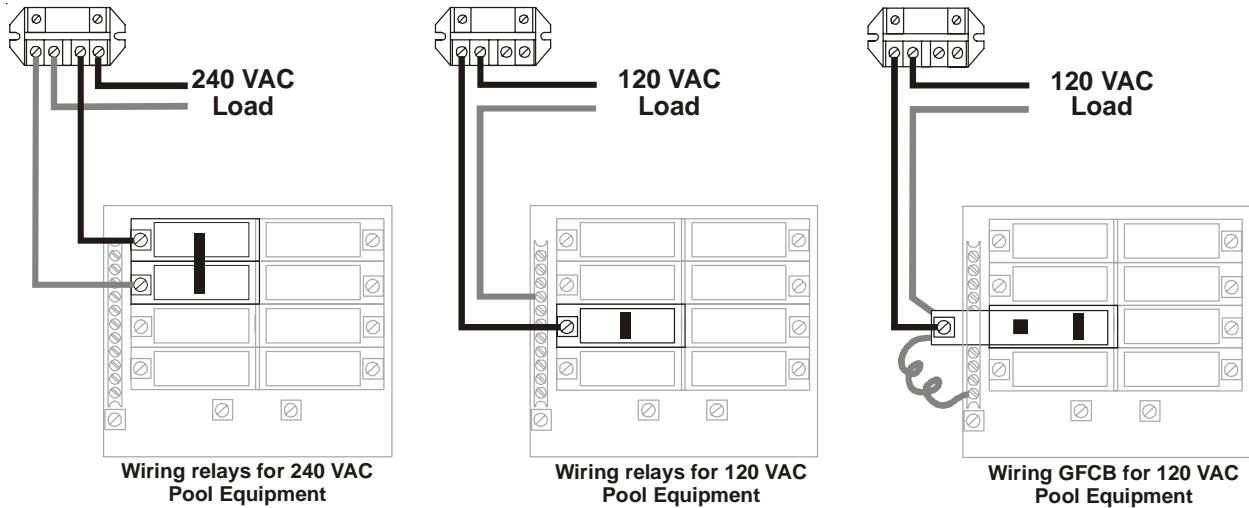

**⚠ WARNING:** Do not use the ECOMMAND to control an automatic pool cover. Swimmers may become entrapped underneath the cover.

**Two speed filter pump:** Requires 2 relays (FILTER plus an optional AUX relay) for proper operation of both speeds. **⚠ IMPORTANT:** Be sure to follow the wiring diagram below AND to configure the control logic according to the instructions on page 13.

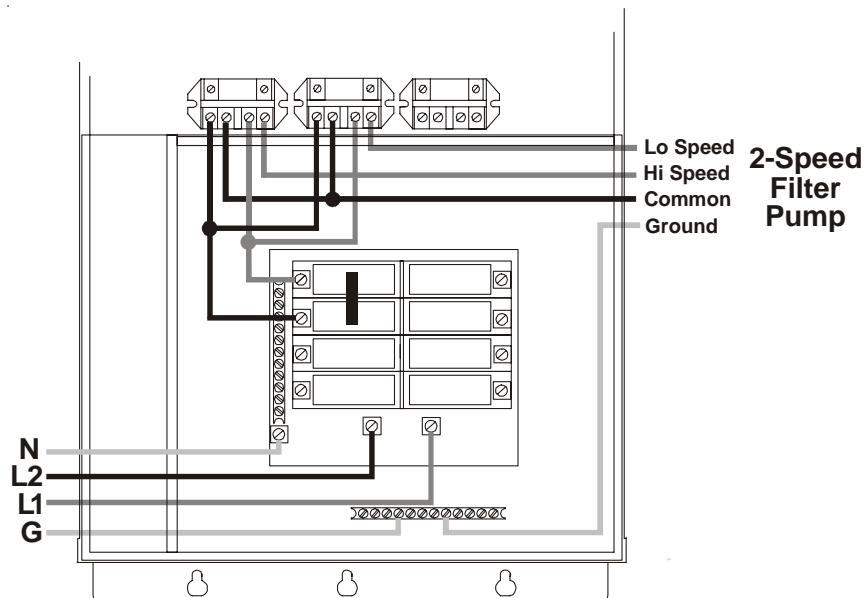

**Lights:** A ground fault circuit breaker must be used to supply power for high voltage pool/spa lighting. Low voltage lights will require an external transformer. For lighting systems that have both a light source and color wheel, connect the light source to the “Lights” relay and then connect the color wheel to an optional AUX relay.

## Low Voltage Wiring

### Valve Actuator

The ECOMMANT can control one valve actuator. Valve3 is for general purpose use (solar, water feature, in-floor cleaner, etc.).

For installations with solar heating, Goldline offers the AQ-SOL-KIT-xx solar kit that contains a valve, actuator, and extra temperature sensor. The “xx” indicates the valve type from the 3 choices below:

- 1P 1.5” Positive Seal
- 2P 2” Positive Seal

The ECOMMANT is compatible with standard valve actuators manufactured by Hayward, Pentair/Compool, and Jandy. See diagram on page 5 for the location of the valve connector.

### Heater Control

The ECOMMANT provides a set of low voltage dry contacts that can be connected to most gas heaters or heat pumps with 24V control circuits. Refer to the diagram below for a generic connection. The manuals supplied with most heaters also include specific wiring instructions for connecting the heater to an external control (usually identified as “2-wire” remote control). For millivolt or line voltage heaters, contact Goldline Tech support, 908-355-7995. Refer to the diagrams and the information on the following pages for more details on the connection to several popular heaters.

### Generic Heaters

1. Wire heater to 120/240V power source per the instructions in the heater manual. The ECOMMANT does NOT control the power going to the heater.
2. Wire the ECOMMANT dry contact heater output per the diagram below. Many internal parts of the heater can get very hot--see the heater manufacturer’s recommendations on the minimum temperature rating for wires. If no guidance is given, use 105°C rated wire.
3. Set any ON/OFF switch on the heater to ON.
4. Set the thermostat(s) on the heater to the maximum (hottest) setting.

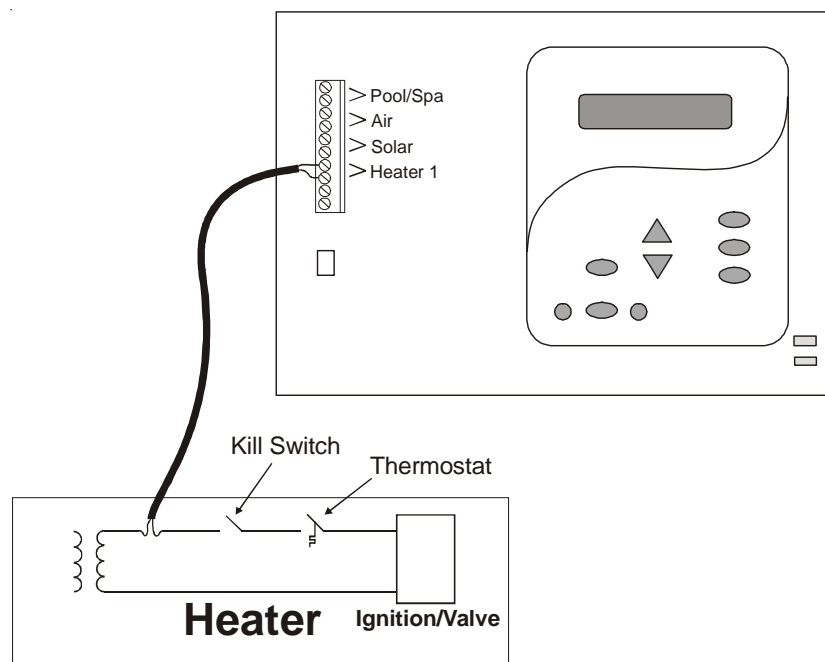

## Laars Heaters

1. Turn power off to heater.
2. Remove factory jumper from terminal block.
3. Wire ECOMMANT to the heater as shown.
4. Ensure toggle switch is in the ON position.
5. Set heater thermostats to maximum position.

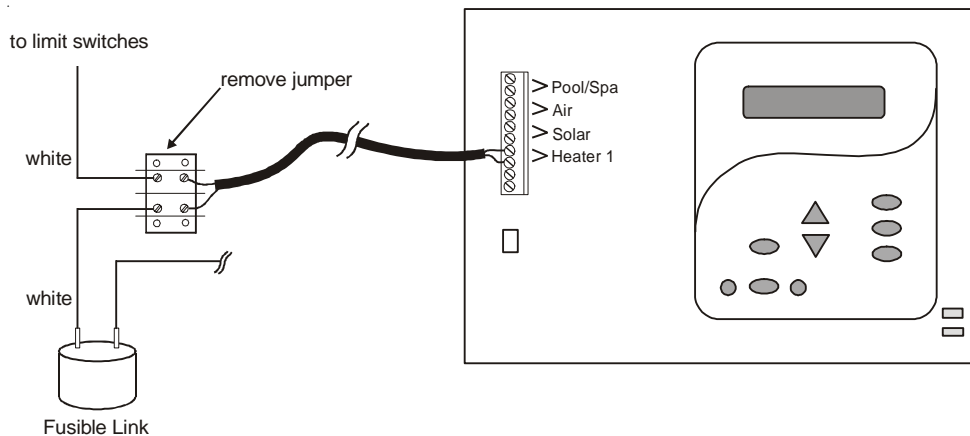

## Hayward Heaters

Refer to the instructions in the heater manual for “2-wire Remote Thermostat” operation under “Remote Control Connections” and the diagram below:

1. Turn off power to heater.
2. Wire ECOMMANT to terminals 1 & 2 (see diagram).
3. Leave jumper attached to terminals 4 & 5.
4. Move “BYPASS” dipswitch on heater circuit board to “ON” position (up).
5. Turn heater power back on.
6. Switch heater to either “Pool” or “Spa” (it doesn’t make any difference which is selected, the ECOMMANT will take control).
7. Heater display should be “bO” (for “bypass On”).
8. Heater will fire whenever ECOMMANT requests (when ECOMMANT “Heater” LED is illuminated).

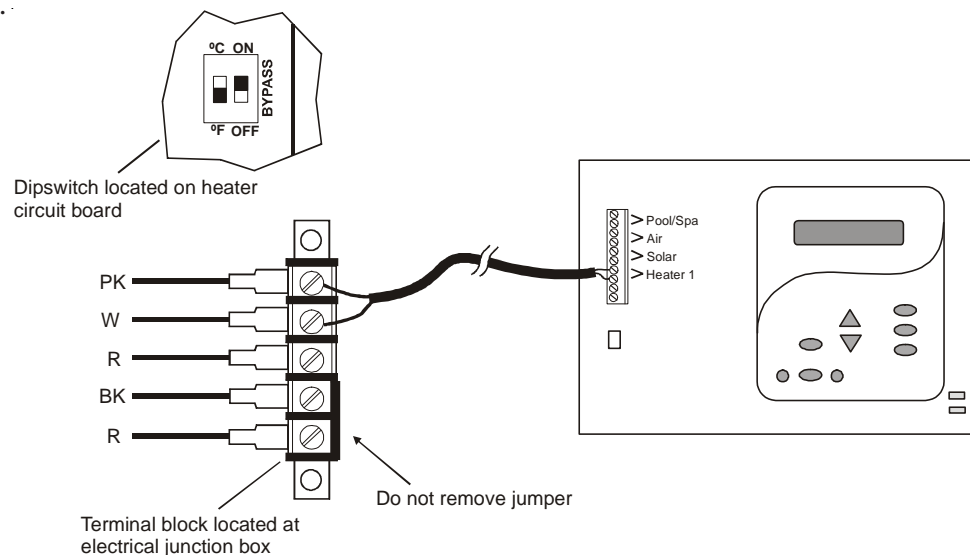

### Pentair/Purex/MiniMax

1. Turn power off to heater.
2. Remove factory installed jumper from the “Ext Switch” connector.
3. Wire the ECOMMANT to the “Ext Switch” connector as shown below.
4. The wires to the ECOMMANT must be separated from any line voltage wires. Failure to follow these instructions may cause erratic operation of the heater.
5. Set the Power (Thermostat Select) switch to either “Pool” or “Spa”.
6. Set the “Pool” and “Spa” thermostats to their maximum settings.

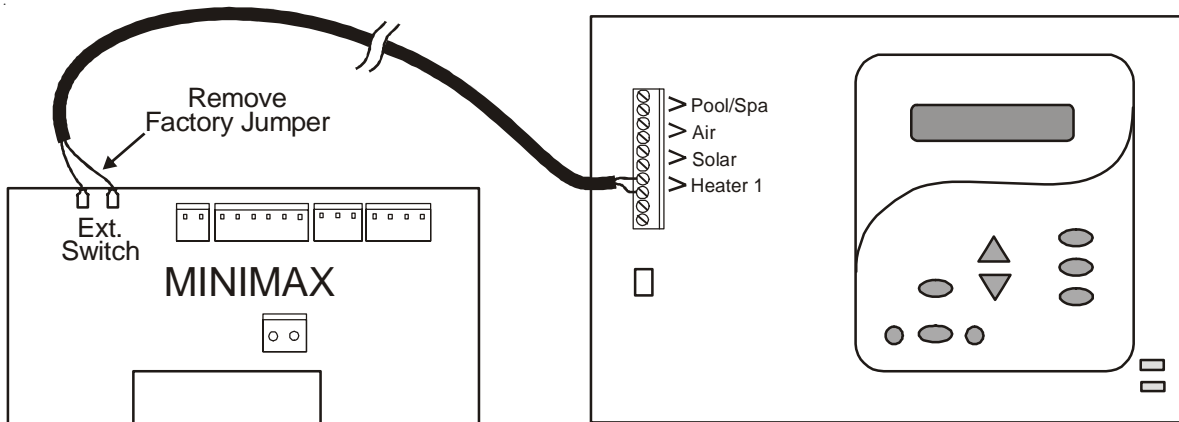

### Raypak RP2100 Pool/Spa Heater

1. Turn power off to heater.
2. Push the mode button to “spa” mode.
3. Set the temperature to the maximum.
4. Push the mode button to “OFF”.
5. Lastly, plug the prewired connector in the P7 position on the board.

**⚠ IMPORTANT:** The heater will display “OFF” when it is being remotely controlled by the ECOMMANT. Some homeowners see the “OFF” display and, thinking this is a mistake, change the mode to “POOL” or “SPA” which then disables the remote control by the ECOMMANT. To prevent this: Remove the heater touch pad connector (P5) which will disable the touchpad.

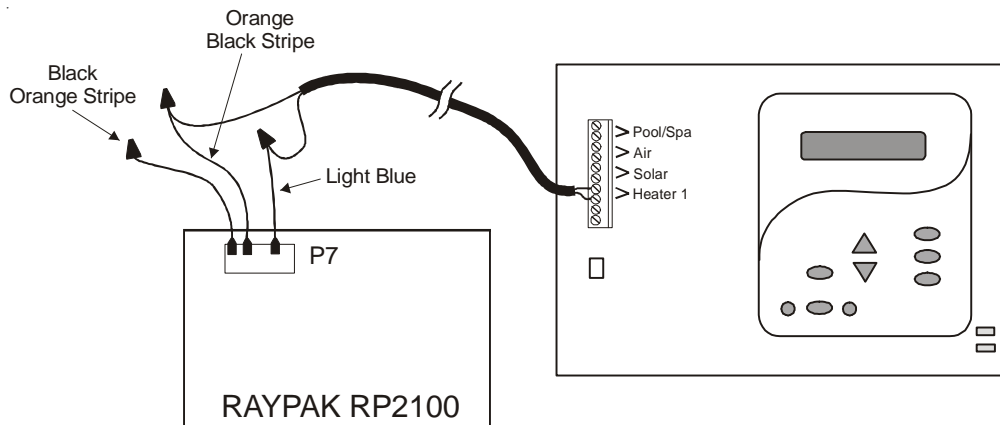

*Drawing is for digital heater. If heater is a millivolt (analog), run red wires from Fireman's Switch to heater relay.*

## **STA-RITE Heater**

1. Turn power off to heater.
2. Remove upper jacket and open the control box.
3. Remove the jumper for the “fireman’s switch.
4. Wire to the ECOMMANT using wire rated for 105°C minimum.

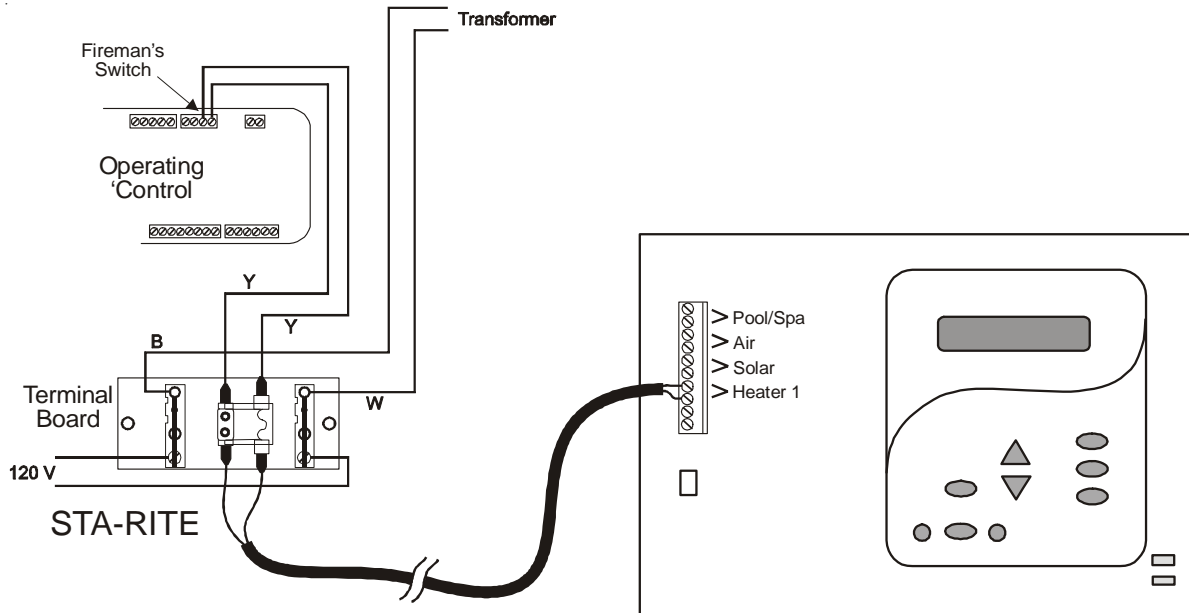

## **Temperature Sensors**

The ECOMMANT utilizes 10K ohm thermistor type sensors. Two sensors (water temperature and air temperature) are included. If the ECOMMANT is being used to control a solar heating system, the solar sensor is required. The sensors are provided with a 15 ft. cable. See page 3 and 11 for installation information.

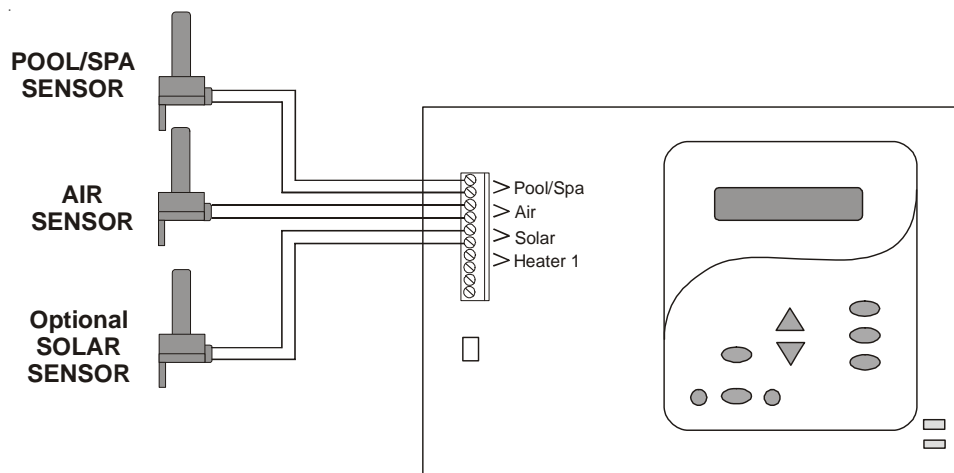

### **HPC-RF-KIT (Wireless Handheld Remote Kit)**

The HPC-RF-KIT contains a base station and handheld remote control. Before the remote control can be used, the base station must be installed. Refer to the diagram below. Plug in the pigtail connector from the wireless base station into the “wireless” connector on the main PCB in the ECOMMANT control unit. Refer to the HPC-RF-KIT for detailed installation and operation information.

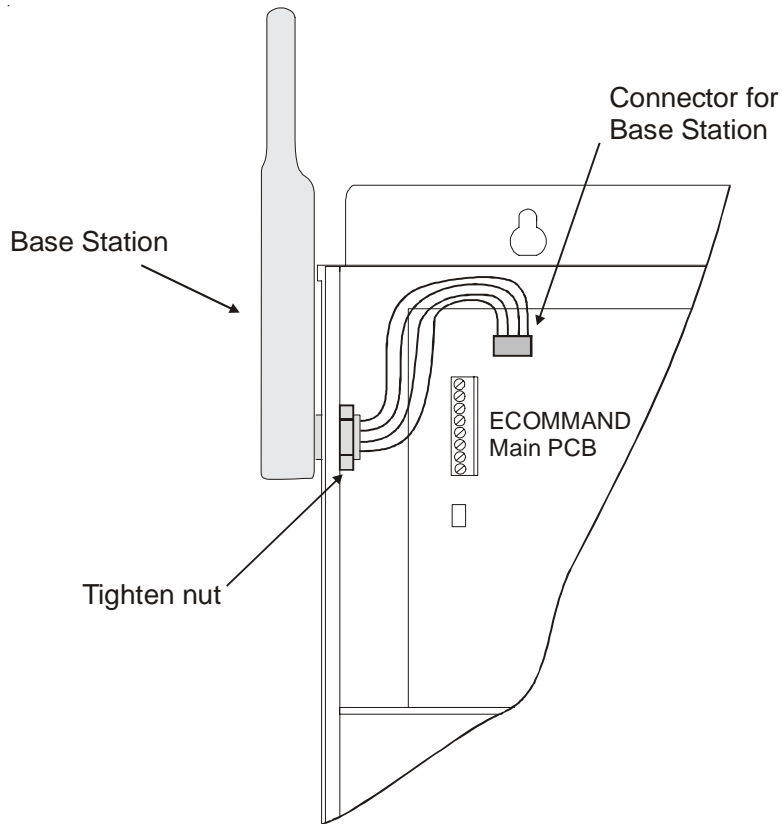



## 4. Configuration

After plumbing and wiring are complete, the ECOMMANT MUST BE CONFIGURED before attempting to operate. Configuration information is entered at the keypad and “tells” the ECOMMANT what equipment is connected and how each should be controlled.

### Accessing the Configuration Menu

Configuring the ECOMMANT requires that you navigate through the Configuration Menu and input various information. For more detailed information about using the ECOMMANT menu system, refer to the Operation Manual.











#### To access the Configuration Menu

Configuration Menu-Locked	 Press repeatedly until “Configuration Menu” is displayed
	 Press BOTH buttons SIMULTANEOUSLY for 5 seconds to unlock
Configuration Menu-Unlocked	 Move to configuration menu

NOTE: The configuration menu automatically “locks” after 2 minutes of no buttons being pressed to prevent unauthorized people from changing the control logic inadvertently and possibly damaging the pool equipment or causing a “call back” to fix the configuration.

### Configuration Menu Items

Each item needs to be programmed and may contain additional sub-menu items. Refer to the following pages for information on programming.

Filter Pump Config. + to view/change	 Push to access pump options
	 Move to previous/next configuration menu
Filter Pump 1 Speed	 Toggle between 1-speed (default) and 2-speed options
	 Move to next menu item
Freeze Protect Enabled	 Toggle between Enabled (default) and Disabled Freeze Protection
	 Move to next menu item or previous/next configuration menu
<i>if “Freeze Protect” is enabled and “2-speed Filter” is selected</i>	
Freeze Protect High Speed	 Toggle between high speed (default) and low speed
	 Move to next menu item
Freeze Temp 38°F	 Adjust the desired freeze protection temperature (33°F - 42°F)
	 Move to previous/next configuration menu

#### Filter Pump

Select single speed or 2-speed pump. If a 2-speed pump is configured, an optional AUX relay must also be configured to control the low speed motor winding on the pump (see page 7 for wiring and page 17 for AUX configuration). See the Operation Manual for specific information regarding the control logic for 2-speed pump operation.

#### Freeze Protection

Freeze protection is used to protect the pool and plumbed equipment against freeze damage. If freeze protection is enabled and the AIR temperature sensor falls below the freeze threshold, the ECOMMANT will turn on the filter pump to circulate the water.













### Freeze Protection Speed

This menu only appears if freeze protection is enabled and the pump is configured for 2-speed. This is the speed that the pump will run at during freeze protection operation. Select high (default) or low speed operation.

### Freeze Protection Temperature

Select the temperature to be used for freeze protection. Temperature is adjustable from 33°F - 42°F (1°C - 6°C). 38°F (3°C) is default. This threshold will be used for all outputs that have freeze protection enabled.

Heater1 Config. + to view/change	 Push to access heater options
	 Move to previous/next configuration menu
Heater1 Disabled	 Toggle between Enabled and Disabled (default) Heater 1
	 Move to next menu item or previous/next configuration menu
<i>if "Heater1" is enabled</i> Heater1 Cooldown Disabled	 Toggle between Enabled and Disabled (default) Heater 1 Cooldown
	 Move to next menu item
<i>if "Heater1" is enabled</i> Heater1 Extend Disabled	 Toggle between Enabled and Disabled (default) Heater 1 Extend
	 Move to previous/next configuration menu
<i>if "Heater1" is enabled and 2-speed filter pump is enabled</i> Allow Low Speed Disabled	 Toggle between Enabled and Disabled (default)
	 Move to next menu item or previous/next configuration menu

### Heater1

If the heater is "Enabled", the heater relay will turn on when the water temperature is less than the desired temperature setting and the filter pump is running. The desired temperature is in the "Settings Menu".

### Heater Cooldown

This feature ensures that the heater cools down before water circulation is stopped. When enabled, the ECOMMAND will continue to run the filter pump for 5 minutes after the heater turns off. During this period the filter pump LED will flash and also a "Heater Cooldown, X:XX remaining" message will scroll on the display.











When the filter pump is running and the heater is on: Pressing the "Filter" button once will cause the heater to turn off, but the filter pump will continue to run for heater cooldown (filter LED flashing and message on display). Pushing the filter button a second time will override the heater cooldown operation and turn the filter pump off.

### Heater Extend

If "Enabled", the filter extend logic keeps the filter pump running beyond the normal turn-off time until the water is heated up to the desired temperature setting (see Settings Menu). Heater extend will NOT cause the filter pump to turn on, it will only delay the turn off time when the heater is operating.

### Allow Low Speed

This menu only appears if the pool filter is configured for 2-speed operation. During default operation, high speed mode is used whenever the heater is on. If Allow Low Speed is "Enabled", low speed will be allowed whenever the heater is on.

Solar Config. + to view/change	 Push to access solar options  Move to previous/next configuration menu
Solar Disabled	 Toggle between Enabled and Disabled (default) Solar  Move to next menu item or previous/next configuration menu
<i>if "Solar" is enabled</i> Solar Extend Disabled	 Toggle between Enabled and Disabled (default) Solar Extend  Move to next menu item
<i>if "Solar" is enabled</i> Solar Priority Disabled	 Toggle between Enabled and Disabled (default) Solar Priority  Move to next menu item or previous/next configuration menu
<i>if "Solar" is enabled and "2-speed Filter" is selected</i> Allow Low Speed Disabled	 Toggle between Enabled and Disabled (default)  Move to previous/next configuration menu

### Solar

If the solar control logic is “Enabled”, several additional steps must be taken to ensure proper operation of the solar system. If the solar is operated by a valve, then the Valve3 output must be setup for solar logic (page 18). If the solar is operated by a pump, then the optional Aux relay one of the AUX relays must be set up for solar logic (page 17). Also, the “solar” temperature sensor must be installed. This sensor is typically mounted near the collector array and is used to sense whether sufficient solar heat is available.

If solar is “Enabled”, the valve or solar pump relay will turn on when the water temperature is less than the desired temperature setting AND the solar sensor is hotter than the water. The desired temperature is in the “Settings Menu”. If applicable, the homeowner will be prompted to enter separate pool and spa desired temperature settings. Depending on the position of the pool/spa suction valve, the proper temperature setting will be used.

### Solar Extend











If “Enabled”, the filter extend logic keeps the filter pump running beyond the normal turn-off time if solar heat is still available. When solar heat is no longer available, both the solar valve/pump and filter pump will turn off simultaneously. Solar extend will NOT cause the filter pump to turn on, it will only delay the turn off time when solar is operating.

### Solar Priority

If both “Solar Control” and “Heater Control” are enabled, the Solar Priority feature will keep the conventional heater off whenever solar heat is available. This provides the most cost effective way of heating the pool. When solar heat is not available, the conventional heater will operate normally.

### Allow Low Speed

This menu only appears if the pool filter is configured for 2-speed operation. During default operation, high speed mode is used whenever the solar heater is on. If Allow Low Speed is enabled, low speed pump operation will be allowed during solar heating except for the first 3 minutes after solar heat turns on.

Lights Config. + to view/change	 Push to access Lights options  Move to previous/next configuration menu item
Lights Function Manual On/Off	 Rotates between Manual On/Off (default), Countdown Timer, Timeclock, Solar, and Low speed of a 2-speed pump options  Move to next menu item
<i>for manual on/off, countdown timer and timeclock functions</i>	
Lights Relay Standard	 Toggle between Standard (default) and Dimmer  Move to next menu item or previous/next configuration menu
<i>for all functions except solar and low speed of 2-speed filter pump and dimmer</i>	
Lights Interlock Disabled	 Toggle between Enabled and Disabled (default) Lights Interlock  Move to next menu item
<i>for all functions except low speed of 2-speed filter pump</i>	
Lights Freeze Disabled	 Toggle between Enabled and Disabled (default) Lights Freeze Protection  Move to previous/next configuration menu

### Lights Function

Although designated as the “Lights” output, the function of the lights relay is similar to the aux1 relay. If pool lights are wired to the lights relay, some options including Solar function, Low Speed of a 2-Speed Filter Pump, Lights Interlock and Lights Freeze Protection will not be necessary and should be disabled. If no pool lights are used, the lights relay can be used to control other pool devices that may require these options. The function of each option is shown below.

*Manual On/Off*—the lights relay will alternate between turning on and off when the LIGHTS button is pressed. There is no automatic control logic.

*Countdown Timer*—the lights relay will turn on when the LIGHTS button is pressed. The lights relay will turn off automatically after a programmed time (see Timers Menu in Operation Manual). The LIGHTS button can also be used to turn the output off.

*Timeclock* – the lights relay will turn-on and turn-off at the times set for the lights timeclock in the Timers Menu (see Timers Menu in Operation Manual). The LIGHTS button can also be used to turn the output on and off.

*Solar* – the lights relay can operate a solar booster pump which will turn on when the filter pump is running and solar heat is available and the water is less than the desired temperature setting. It is important to note that “Solar Control” must be enabled in the “Solar Config.” menu for proper operation to occur.

*Low Speed of a 2-speed Filter Pump* – the ECOMMAND will turn on the lights relay whenever the low speed operation of the filter pump is required. It is very important that the “2-speed” filter pump option be selected under the “Filter Config.” Menu for proper operation.

### Lights Relay

This feature allows the user to select either “Standard” (default) or “Dimmer” type relay for the Lights output. The optional AQL-DIM dimmer kit must be installed if “Dimmer” is desired. When “Dimmer” is selected, and the Lights output is manually turned on, the “+” and “-” buttons adjust the level from 20% to 100% (default). The level is saved for the next time the lights are turned from off to on.













### Lights Interlock

If enabled, this feature will override the function (Manual On/Off, Countdown Timer, Timeclock) selected above and turn the lights relay off when: filter pump is off, first 3 minutes of filter pump operation (allows the pump to prime and get water flowing), when the pool/spa suction return valves are in any position other than “pool only”, or for the first 3 minutes after solar turns on (allows air in the solar panels to be purged). Interlock is not available for solar, low speed filter pump, or dimmer.

### Lights Freeze Protection

This function helps protect equipment that is wired to the lights relay against freeze damage. If Freeze Protection is enabled and the AIR temperature sensor falls below the selected freeze temperature threshold, the ECOMMAND will energize the lights relay. IMPORTANT: this only enables operation of the lights relay during freeze--see the “Filter Pump Config.” menu to enable freeze protection for the main circulation system.

## Requires the use of the optional AQL-RELAY-DC-KT

Aux1 Config. + to view/change	 Push to access Aux1 options
	 Move to previous/next configuration menu item
Aux1 Output Enabled	 Toggle between Enabled and Disabled (default)
	 Move to previous/next configuration menu item
<i>if Aux1 is enabled</i> Aux1 Function Manual On/Off	 Rotates between Manual On/Off (default), Countdown Timer, Timeclock, Solar, and Low speed of a 2-speed pump options
	 Move to next menu item
<i>for manual on/off, countdown timer and timeclock functions if Aux1 is enabled</i>	
Aux1 Relay Standard	 Toggle between Standard (default) and Dimmer
	 Move to next menu item or previous/next configuration menu
<i>for all functions except solar and low speed of 2-speed filter pump and dimmer if Aux1 is enabled</i>	
Aux1 Interlock Disabled	 Toggle between Enabled and Disabled (default) Aux1 Interlock
	 Move to next menu item
<i>for all functions except low speed of 2-speed filter pump if Aux1 is enabled</i>	
Aux1 Freeze Enabled	 Toggle between Enabled (default) and Disabled Aux1 Freeze
	 Move to previous/next configuration menu

 **WARNING: Do not use the ECOMMAND to control an automatic pool cover. Swimmers may become entrapped underneath the cover.**

### Aux1 Output

The ECOMMAND features an optional auxiliary function that can be used to control a variety of pool equipment. This feature is disabled by default. If the auxiliary function is desired, the optional AQL-RELAY-DC-KT must be installed and the Aux1 output must be enabled.

### Aux1 Function

*Manual On/Off (default)*—the aux relay will alternate between turning on and off when the aux button is pressed. There is no automatic control logic.

*Countdown Timer* – the aux relay will turn on when the AUX button is pressed and then will turn off automatically after a programmed time (see Timers Menu, Operation Manual). The AUX button can also be used to turn the output off.

*Timeclock* – the aux relay will turn-on and turn-off at the times set for the aux1 timeclock in the Timers Menu. The AUX button can also be used to turn the output on and off.

*Solar* – the aux relay operates a solar booster pump which will turn on when the filter pump is running and solar heat is available and the water is less than the desired temperature setting. It is important to note that “Solar Control” must be enabled in the “Solar Config.” menu for proper operation to occur.

*Low Speed of a 2-speed Filter Pump* – the ECOMMAND will operate the aux relay whenever the low speed operation of the filter pump is required. It is very important that the “2-speed” filter pump option be selected under the “Filter Config.” Menu for proper operation.

### Aux1 Relay

This feature allows the user to select either “Standard” (default) or “Dimmer” type relay for the Aux1 output. The optional AQL-DIM dimmer kit must be installed if “Dimmer” is desired. When “Dimmer” is selected, and the Aux1 output is manually turned on, the “+” and “-” buttons adjust the level from 20% to 100% (default). The level is saved for the next time the aux1 output is turned from off to on.

### Aux1 Interlock

If “Enabled”, this feature will override the function (Manual On/Off, Countdown Timer, Timeclock), selected above and turn the aux1 off when: filter pump is off, first 3 minutes of filter pump operation (allows the pump to prime and get water flowing), when the pool/spa suction return valves are in any position other than “pool only”, or for the first 3 minutes after solar turns on (allows air in the solar panels to be purged). Interlock is not available for solar, low speed filter pump, or dimmer.

### Aux1 Freeze Protection

This function protects the pool, plumbing, and equipment against freeze damage. If Freeze Protection is enabled and the AIR temperature sensor falls below the selected freeze temperature threshold, the ECOMMAND will turn on the aux relay to circulate the water. IMPORTANT: this only enables operation of the AUX output during freeze--see the “Filter Pump Config.” menu to enable freeze protection for the main circulation system.

Valve3 Config. + to view/change	▲ Push to access Valve3 options
Valve3 Function Solar	⏪ Move to previous/next configuration menu item
<i>for all functions except solar and valve3=x</i>	
Valve3 Interlock Disabled	▲ Rotates between Timeclock (default), Solar, In-Floor Cleaner, and Valve3=Filter, Valve3=Lights, and Valve3=Aux1
<i>for all functions except solar and valve3=x</i>	
Valve3 Freeze Disabled	⏩ Move to next menu item
<i>for all functions except solar and valve3=x</i>	
Valve3 Freeze Disabled	▲ Toggle between Enabled and Disabled (default) Valve3 Interlock
<i>for all functions except solar and valve3=x</i>	
Valve3 Freeze Disabled	⏪ Move to previous/next configuration menu

### Valve3 Function

*Timeclock (default)* – the valve turns on/off at the times set for the valve3 timeclock in the Timers Menu (see Operations Manual).

*Solar* – the valve operates when the filter pump is running and solar heat is available and the water is less than the desired temperature setting. Solar heating must be enabled in the “Solar Config. menu for proper operation to occur.

*In-Floor Cleaner* – the valve switches the water returning to the pool between the in-floor cleaner and the normal return jets which facilitate efficient surface skimming. The valve will

operate the in-floor cleaner for the first half of each clock hour and then switch to the jets/skimming for the last half of the hour.

*Valve3=Filter* – the valve operates whenever the Filter relay is on.

*Valve3=Lights* – the valve operates whenever the Lights relay is on.

*Valve3=Aux1* – the valve operates whenever the Aux1 relay is on.



### Valve3 Interlock

If “Enabled”, this feature will override the function (timeclock or in-floor cleaner) selected above and turn the valve off when: the filter pump is off, first 3 minutes of filter pump operation (allows the pump to prime and get water flowing), when the pool/spa suction return valves are in any position other than “pool only”, or for the first 3 minutes after solar turns on (allows air in the solar panels to be purged). Interlock is not available for solar, low speed filter pump, or dimmer.

### Valve3 Freeze Protection



This function protects the pool and plumbed equipment against freeze damage. If Freeze Protection is enabled and the AIR temperature falls sensor falls below the selected freeze temperature threshold, the ECOMMAND will turn on the valve to allow circulation of the water. **IMPORTANT:** this only enables operation of the valve3 output during freeze--see the “Filter Pump Config.” menu to enable freeze protection for the main circulation system.

All Timeclocks  
7-day



-  Toggle between 7-day (default) and Weekend/Weekday time options
-  Move to previous/next configuration menu

This selection affects ALL of the timeclock logic in the ECOMMAND. If “7-day” is selected, each timeclock will have one set of turn-on/turn-off settings that operate every day of the week. If “Weekend/Weekdays” option is selected then the user can enter one set of turn-on/turn-off times for the weekend (fixed as Saturday/Sunday) and another set of turn-on/turn-off times for weekdays (Monday through Friday).



Time Format  
12 hour AM/PM

-  Toggle between 12 hour AM/PM (default) and 24 hour time format options
-  Move to previous/next configuration menu



Units  
°F and PPM

-  Toggle between °F and PPM (default) and °C and g/L (Metric) options
-  Move to previous/next configuration menu

Reset Config. to  
Default Press +

-  Initiate reset of all configuration parameters
-  Move to previous/next configuration menu (config. not reset)

Are you sure?  
+ to proceed

-  Reset all configuration parameters
-  Move to previous/next menu (config. not reset)

Config. reset  
Confirmed

-  Move to previous/next configuration menu

Use this function to erase all previous system configuration and reset all configuration parameters back to the factory default values. This function is NOT reversible--be careful.

## **5. System Startup and Checkout**

### **Before Startup**

Before starting the ECOMMANT for the first time, be sure that the following items have been completed:

1. Properly rated circuit breakers are installed in the ECOMMANT subpanel.
2. All wiring is performed according to NEC and local codes.
3. The ECOMMANT is properly grounded and bonded.
4. The ECOMMANT is properly configured to control all desired functions.

### **Program Automatic Operation**

Refer to the programming flow chart on the back cover of this manual for a listing of the available menus and the items included in each menu.

#### ***Settings Menu***

Heater and/or solar thermostat settings  
Day and Time

#### ***Timers Menu***

Timeclock and/or Countdown timer settings

### **Heater Checkout**

Follow these instructions to verify that the ECOMMANT is properly controlling the heater.

1. Check that the ECOMMANT is calling for the heater to turn on as indicated by the “Heater” LED being illuminated. If the “Heater” LED is illuminated, go directly to step 2; if not, then check the following:
  - The heater is enabled (Configuration Menu/Heater Config.).
  - The heater temperature setting is at least 2°F greater than the water temperature (Settings Menu/Heater).
  - The filter pump is running.
  - If the pool has solar heat and the solar priority feature is enabled (Configuration Menu/Solar Config) then solar must be off in order for the heater to fire. The easiest way to force solar off is to go to the Settings Menu / Solar and temporarily lower the temperature settings below the current water temperature.
2. Check that the heater is running. If not, then check:
  - Power is supplied to the heater.
  - The ECOMMANT control output is properly connected to the heater control (see “Heater Control” wiring, page 8).
  - Some heaters also have internal switches or jumpers that have to be set correctly for remote control operation—refer to the heater manual and also “Heater Control” (page 8).
  - Heater is turned on (“Kill Switch” is in the “ON” position).
  - If a heater bypass valve is installed, check that water is flowing through the heater.
  - The heater temperature setting is set as high as possible (usually 104°F/40°C). Also note that some heat pumps actually have to be set to the lowest possible temperature.



3. Once the heater is running, you can verify the “heater cooldown” feature (optional - see Configuration Menu/Heater Config.) is operating properly:

- Press the “Filter” button once (for 2 speed pumps, this may require 2 pushes of the “Filter” button).
- The heater should turn off (“Heater” LED off) and the “Filter” LED will flash to indicated heater cooldown is active.
- The display will periodically indicate that the filter pump is on for heater cooldown and show the minutes remaining.
- The pump will automatically turn off at the end of the 5 minute heater cooldown period.

For more detailed instructions on control and operation of the ECOMMAND system, refer to the Operation Manual.

### ***Service Mode***

Service mode disables all automatic control operation and is intended to be used when servicing the pool system. To enter service mode, push the SERVICE button once on the main unit keypad. This will initially turn all outputs off and then allow you to turn outputs on/off manually at the main display (only). In service mode, the buttons on the optional remote display/keypad and the optional spa side remote will turn outputs off, but will not turn any output on. Heater control output and solar control output are prevented from turning on if the water temperature exceeds 104°F (40°C).

Pushing the SERVICE button again will enter a timed service mode. Service operation as described above will continue for 3 hours, then automatically return to normal operation.

Push the SERVICE button once more to exit out of Service mode.



*The following statement is applicable if the wireless remote control is connected to the ECOMMAND system.*

## **FCC Statement**

(Compliance Statement, Part 15.19): This device complies with Part 15 of the FCC Rules. Operation is subject to the following two conditions: (1) This device may not cause harmful interference, and (2) this device must accept any interference received, including interference that may cause undesired operation.

WARNING (Part 15.21): Changes or modifications not expressly approved by the party responsible for compliance could void the user's authority to operate this equipment.

## **Industry Canada Statement**

The term "IC" before the certification/registration number only signifies that the Industry Canada technical specifications were met.

## **Interference**

This equipment has been tested and found to comply with the limits for a Class B digital device, pursuant to Part 15 of the FCC rules. These limits are designed to provide reasonable protection against harmful interference in a residential installation. This equipment generates, uses, and can radiate radio frequency energy and, if not installed and used in accordance with the instructions, may cause harmful interference to radio communications. However, there is no guarantee that interference will not occur in a particular installation. If this equipment does cause harmful interference to radio or television reception, which can be determined by turning the equipment off and on, then the user is encouraged to try to correct the interference by one or more of the following measures:

- Reorient or relocate the receiving antenna.
- Increase the separation between the equipment and the receiver.
- Connect the equipment into a power source on different circuit than the receiver.
- Consult the dealer or an experienced radio/TV technician for help.



**LIMITED WARRANTY** Goldline warrants its Aqua Rite, Aqua Rite Pro, Aqua Trol, Aqua Logic and Pro Logic products (products with Goldline part numbers starting with AQ-RITE-, AQ-RT-PRO, AQ-TROL-, AQ-LOGIC-, AQL-P-, AQL-PS-, AQL-CL-, PL-P-, PL-PS-, and HPC-2) to be free from defects in material or workmanship, under normal use and service:

For **three years** from the date of the initial system installation on private, residential swimming pools within the USA or Canada and **one year** from the date of initial system installation on commercial installations, installations outside of the USA or Canada and for any replacement parts or accessory products, provided they are installed in accordance with the Goldline installation instructions and specifications provided with the product. If written proof of the date of the initial system installation is not provided to Goldline, the manufacturing datecode on the Aqua Rite, Aqua Rite Pro, Aqua Trol, Aqua Logic and Pro Logic electronics unit will be the sole determinant of the date of the initial system installation.

For residential installations in USA or Canada: If a product is defective in workmanship or materials and is removed and returned freight prepaid within three (3) years after the date of the initial system installation, Goldline will, at its option, either repair or replace the defective product and return it freight prepaid.

For commercial installations, installations outside the USA and Canada, and accessory products and replacement parts: If a product is defective in workmanship or materials and is removed and returned freight prepaid within one (1) year after the date of the initial system installation, Goldline will, at its option, either repair or replace the defective product and return it freight prepaid.

Contact any Goldline dealer or contact Goldline at 61 Whitecap Drive, North Kingstown, RI 02852 for warranty service. The costs incurred in removal and/or reinstallation of the product are NOT covered under this warranty. Some states do not allow limitations on how long an implied warranty lasts, so the above limitation may not apply to you.

**WARRANTY EXCLUSIONS:**

1. Material supplied or workmanship performed by others in process of installation.
2. Damage resulting from improper installation including installation on pools larger than the product rating.
3. Problems resulting from failure to operate the product(s) in accordance with the recommended instructions contained in product's owners manual(s).
4. Problems resulting from failure to maintain pool water chemistry in accordance with the recommendations in the owners manual(s).
5. Problems resulting from tampering, accident, abuse, negligence, unauthorized repairs or alternations, fire, flood, lightning, freezing, external water, degradation of natural stone used in or immediately adjacent to a pool or spa, war or acts of God.

**DISCLAIMER. THE EXPRESS LIMITED WARRANTY ABOVE CONSTITUTES THE ENTIRE WARRANTY OF GOLDLINE WITH RESPECT TO ITS POOL AUTOMATION AND CHLORINATION PRODUCTS AND IS IN LIEU OF ALL OTHER WARRANTIES, EXPRESSED OR IMPLIED, INCLUDING WARRANTIES OF MERCHANTABILITY OR FITNESS FOR A PARTICULAR PURPOSE. THIS WARRANTY GIVES YOU SPECIFIC LEGAL RIGHTS, AND YOU MAY ALSO HAVE OTHER RIGHTS WHICH VARY FROM STATE TO STATE. IN NO EVENT SHALL GOLDLINE BE RESPONSIBLE FOR ANY CONSEQUENTIAL, SPECIAL OR INCIDENTAL DAMAGES OF ANY NATURE WHATSOEVER, INCLUDING, BUT NOT LIMITED TO, PERSONAL INJURY, PROPERTY DAMAGE, DAMAGE TO OR LOSS OF EQUIPMENT, LOST PROFITS OR REVENUE, COSTS OF RENTING REPLACEMENTS, AND OTHER ADDITIONAL EXPENSES, EVEN IF THE SELLER HAD BEEN ADVISED OF THE POSSIBILITY OF SUCH DAMAGES. SOME STATES DO NOT ALLOW THE EXCLUSION OF LIMITATION OF INCIDENTAL OR CONSEQUENTIAL DAMAGES, SO THE ABOVE LIMITATION OR EXCLUSION MAY NOT APPLY TO YOU.**

NO WHOLESALE, AGENT, DEALER, CONTRACTOR OR OTHER PERSON IS AUTHORIZED TO GIVE ANY WARRANTY ON BEHALF OF GOLDLINE.

THIS WARRANTY IS VOID IF THE PRODUCT HAS BEEN ALTERED IN ANY WAY AFTER LEAVING THE FACTORY.

# ECOMMAND Programming Flow Chart

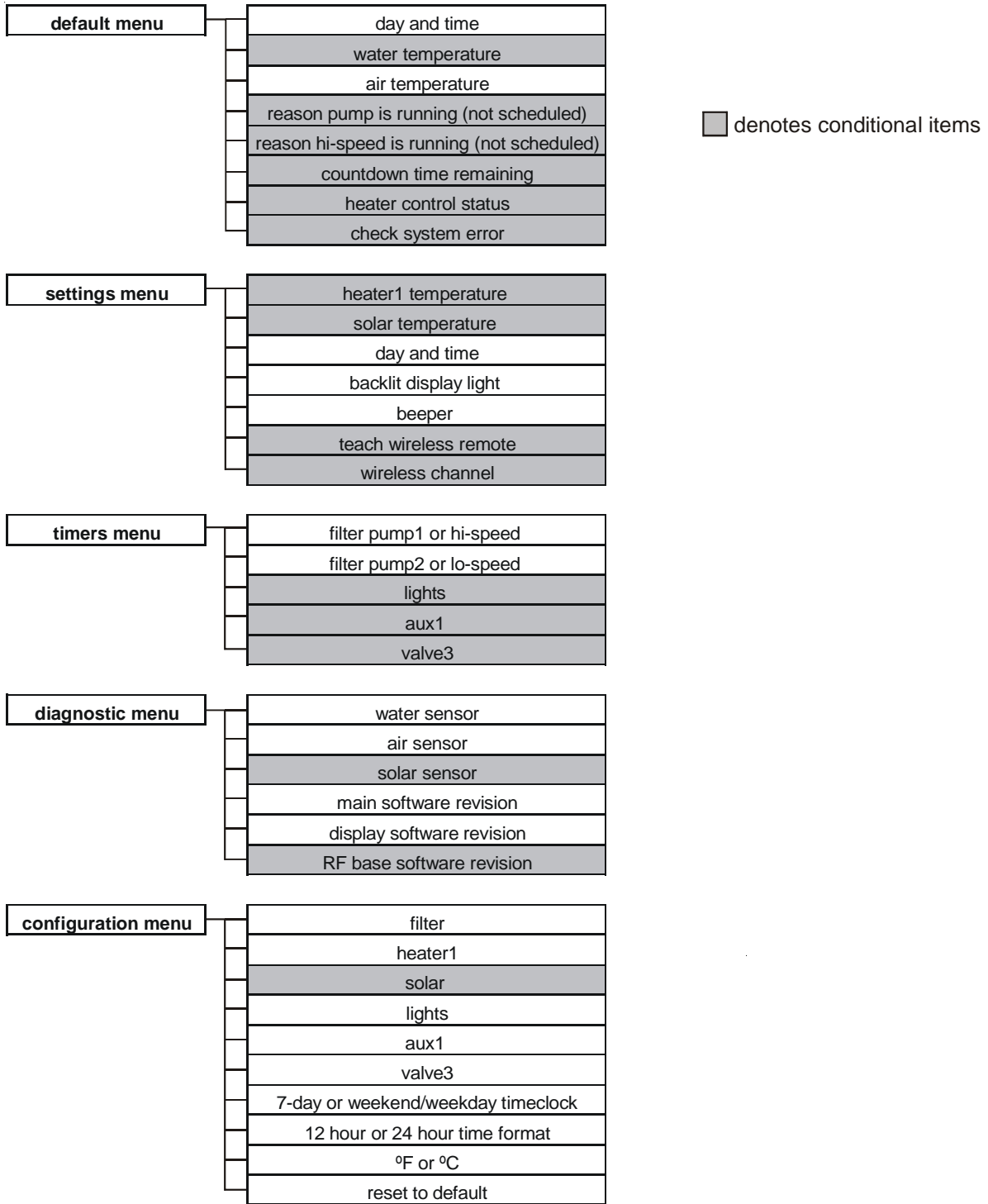

**HAYWARD**

620 Division St.  
Elizabeth, NJ 07207