

AQUA RITE™ *pro*

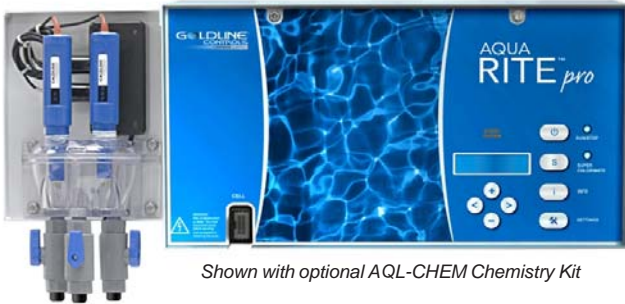

Electronic Chlorine Generator

Operation and Installation Manual

AQ-RT-PRO

IMPORTANT SAFETY INSTRUCTIONS

- **READ AND FOLLOW ALL INSTRUCTIONS**
- **WARNING** – To reduce the risk of injury, do not permit children to use this product unless they are closely supervised at all times.
- A wire bonding lug is provided on the lower external surface (two for Canadian models) of this unit to connect a minimum 8 AWG (8.4 mm²) solid copper conductor between this unit and any metal equipment, metal enclosures of electrical equipment, metal water pipe, or conduit within 5 feet (1.5 m) tying the unit to the local bonding grid.
- Use Copper Conductors Only
- Disconnect all AC power during installation.
- A green colored terminal marked “Ground” is located inside the wiring compartment. To reduce the risk of electric shock, this terminal must be connected to the grounding means provided in the electric supply service panel with a continuous copper wire equivalent in size to the circuit conductors supplying the equipment.
- All field installed metal components such as rails, ladders, drains, or other similar hardware within 3 meters of the pool, spa or hot tub shall be bonded to the equipment grounding bus with copper conductors not smaller than 8 AWG US / 6 AWG Canada.
- **NOTICE TO USERS:** This control product is to be used only in accordance with the directions of this label. It is an offense under the Pest Control Products Act to use a control product under unsafe conditions.
- **SAVE THESE INSTRUCTIONS**

Table of Contents

OPERATION

General.....	1
Water Chemistry.....	1
Controls.....	6
Information Menu.....	7
Settings Menu.....	9
Operation.....	11
Maintenance.....	12

INSTALLATION

Mounting.....	13
Plumbing.....	14
Wiring.....	15

TROUBLESHOOTING

Troubleshooting.....	18
----------------------	----

WARRANTY

Warranty.....	20
---------------	----

OPERATION

The Aqua Rite Pro is an automatic chlorine generation system for pool or spa sanitation. The operation requires a low concentration of salt (sodium chloride) in the pool water. These levels are low enough that it normally will not be tasted. The Aqua Rite Pro automatically sanitizes your pool by converting the salt into free chlorine which kills bacteria and algae in the pool. Chlorine will revert back to sodium chloride after killing bacteria. These reactions will continuously recycle virtually eliminating the need to add sanitizing chemicals to your pool. The only time you may need to add more salt to the pool is when water is replenished due to backwashing, draining, or splashing (not evaporation).

The Aqua Rite Pro is designed to handle the purification needs of most residential swimming pools up to 40,000 gallons (150,000 liters), or the needs of most commercial pools up to 25,000 gallons (95,000 liters). Check local codes for other restrictions. The actual amount of chlorination required to properly sanitize a pool varies due to bather load, rainfall, temperature, and the pool's cleanliness.

The Aqua Rite Pro can be used with the optional Goldline AQL-CHEM to provide a fully integrated chemistry solution for your pool. With the AQL-CHEM installed, the Aqua Rite Pro senses the pool's ORP and pH levels and automatically generates the correct amount of chlorine to keep your pool properly sanitized. The Aqua Rite Pro can also control pH by introducing acid or CO₂ into the pool using an AQL-CHEM2 (120V), AQL-CHEM2-240 (240V) or other dispensing device requiring 120VAC or 240VAC on/off control. The Aqua Rite Pro and AQL-CHEM products offer the user a complete automated system controlling both sanitization and pH balance.

NOTE: Goldline does not recommend using the Aqua Rite Pro to generate bromine.

NOTE: Before installing this product as part of a saline water purification system in a pool or spa using natural stone for coping or for immediately adjacent patios/decking, a qualified stone installation specialist should be consulted regarding the appropriate type, installation, sealant (if any) and maintenance of stone used around a saline pool with electronic chlorine generator in your particular location and circumstances.

Water Chemistry

The table below summarizes the levels that are recommended by The Association of Pool and Spa Professionals (APSP). The only special requirements for the Aqua Rite

CHEMICAL	IDEAL LEVELS
Salt	2700 to 3400 ppm
Free Chlorine	1.0 to 3.0 ppm
pH	7.2 to 7.6
Cyanuric Acid (Stabilizer)	60 to 80 ppm (80 ppm best)
Total Alkalinity	80 to 120 ppm
Calcium Hardness	200 to 400 ppm
Metals	0 ppm
Saturation Index	-.2 to .2 (0 best)

Pro are the salt level and stabilizer. It is important to maintain these levels in order to prevent corrosion or scaling and to ensure maximum enjoyment of the pool. Test your water periodically. Your authorized Aqua Rite Pro dealer or most pool stores can provide you with the chemicals and procedures to adjust the water chemistry. Be sure to tell the pool store that you are using an Aqua Rite Pro chlorine generator.

Saturation index

The saturation index (Si) relates to the calcium and alkalinity in the water and is an indicator of the pool water "balance". Your water is properly balanced if the Si is $0 \pm .2$. If the Si is below -0.2 , the water is corrosive and plaster pool walls will be dissolved into the water. If the Si is above $+0.2$, scaling and staining will occur. Use the chart below to determine the saturation index.

$$Si = pH + Ti + Ci + Ai - 12.1$$

°C	°F	Ti	Calcium Hardness	Ci	Total Alkalinity	Ai
12	53	.3	75	1.5	75	1.9
16	60	.4	100	1.6	100	2.0
19	66	.5	125	1.7	125	2.1
24	76	.6	150	1.8	150	2.2
29	84	.7	200	1.9	200	2.3
34	94	.8	250	2.0	250	2.4
39	103	.9	300	2.1	300	2.5
			400	2.2	400	2.6
			600	2.4	600	2.8
			800	2.5	800	2.9

How to use: Measure pool pH, temperature, calcium hardness, and total alkalinity. Use the chart above to determine Ti, Ci, and Ai from your measurements. Insert values of pH, Ti, Ci and Ai into the above equation. If Si equals .2 or more, scaling and staining may occur. If Si equals -0.2 or less corrosion or irritation may occur.

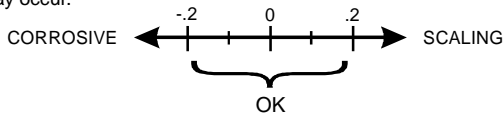

Salt Level

Use the chart on page 4 to determine how much salt in pounds or (Kgs) need to be added to reach the recommended levels. Use the equations below (measurements are in feet/gallons and meters/liters) if pool size is unknown.

	Gallons (pool size in feet)	Liters (pool size in meters)
Rectangular	Length x Width x Average Depth x 7.5	Length x Width x Average Depth x 1000
Round	Diameter x Diameter x Average Depth x 5.9	Diameter x Diameter x Average Depth x 785
Oval	Length x Width x Average Depth x 6.7	Length x Width x Average Depth x 893

The ideal salt level is between 2700-3400 ppm (parts per million) with 3200 ppm being optimal. If the level is low, determine the number of gallons in the pool and add salt according to the chart on page 4. A low salt level will reduce the efficiency of the Aqua Rite Pro and result in low chlorine production. A high salt level can cause the Aqua Rite Pro to shutdown and may begin to give a salty taste to your pool (generally, the salt will begin to be tasted at a level of about 3500-4000 ppm). The salt in your pool/spa is constantly recycled and the loss of salt throughout the swimming season should be small. This loss is due primarily to the addition of water because of splashing, backwashing, or draining (because of rain). Salt is not lost due to evaporation.

Type of Salt to Use

It is important to use only sodium chloride (NaCl) salt that is greater than 99% pure. This is common food quality or water softener salt and is usually available in 40-80 lb. bags labeled "Coarse Solar Salt". It is also acceptable to use water conditioning salt pellets, however, it will take longer for them to dissolve. Do not use rock salt, salt with yellow prussiate of soda, salt with anti-caking additives, or iodized salt.

How to Add or Remove Salt

For new plaster pools, wait 10-14 days before adding salt to allow the plaster to cure. Turn the circulating pump on and add salt directly into the pool. Brush the salt around to speed up the dissolving process--do not allow salt to pile up on the bottom of the pool. Run the filter pump for 24 hours with the suction coming from the main drain (use pool vac if there is no main drain) to allow the salt to evenly disperse throughout the pool. The salt display may take 24 hours to respond to the change in salt concentration.

The only way to lower the salt concentration is to partially drain the pool and refill with fresh water.

Always check stabilizer (cyanuric acid), when checking salt. These levels will most likely decline together. Use the chart on page 5 to determine how much stabilizer must be added to raise the level to 80 ppm.

POUNDS and (Kg) OF SALT NEEDED FOR 3200 PPM

Current salt level ppm	Gallons and (Liters) of Pool/Spa water																
	8,000 (30,000)	10,000 (37,500)	12,000 (45,000)	14,000 (52,500)	16,000 (60,000)	18,000 (67,500)	20,000 (75,000)	22,000 (82,500)	24,000 (90,000)	26,000 (97,500)	28,000 (105,000)	30,000 (112,500)	32,000 (120,000)	34,000 (127,500)	36,000 (135,000)	38,000 (142,500)	40,000 (150,000)
0	213 (97)	267 (121)	320 (145)	373 (170)	427 (194)	480 (218)	533 (242)	587 (267)	640 (291)	693 (315)	747 (339)	800 (364)	854 (388)	907 (412)	960 (436)	1013 (460)	1067 (484)
200	200 (91)	250 (114)	300 (136)	350 (159)	400 (182)	450 (205)	500 (227)	550 (250)	600 (273)	650 (295)	700 (318)	750 (341)	800 (363)	850 (385)	900 (408)	950 (430)	1000 (453)
400	187 (85)	233 (106)	280 (127)	327 (148)	375 (170)	420 (191)	467 (212)	513 (233)	560 (255)	607 (277)	653 (297)	700 (318)	747 (339)	793 (360)	840 (382)	887 (403)	933 (424)
600	173 (79)	217 (98)	260 (118)	303 (138)	347 (158)	390 (177)	433 (200)	477 (217)	520 (236)	563 (256)	607 (276)	650 (297)	693 (317)	737 (337)	780 (358)	823 (378)	867 (398)
800	160 (73)	200 (91)	240 (109)	280 (127)	320 (145)	360 (164)	400 (182)	440 (200)	480 (218)	520 (236)	560 (255)	600 (273)	640 (291)	680 (308)	720 (326)	760 (344)	800 (364)
1000	147 (67)	183 (83)	220 (100)	257 (117)	293 (133)	330 (150)	367 (167)	403 (200)	440 (217)	477 (233)	513 (250)	550 (267)	587 (283)	623 (300)	660 (317)	697 (333)	733 (353)
1200	133 (61)	167 (76)	200 (91)	233 (106)	267 (121)	300 (136)	333 (152)	367 (167)	400 (182)	433 (197)	467 (212)	500 (227)	533 (250)	567 (268)	600 (274)	633 (289)	667 (304)
1400	120 (55)	150 (68)	180 (82)	210 (95)	240 (109)	270 (123)	300 (136)	330 (150)	360 (164)	390 (177)	420 (191)	450 (205)	480 (218)	510 (232)	540 (246)	570 (259)	600 (263)
1600	107 (48)	133 (61)	160 (73)	187 (85)	213 (97)	240 (109)	267 (121)	293 (133)	320 (145)	347 (158)	373 (170)	400 (182)	427 (195)	453 (207)	480 (219)	507 (231)	533 (243)
1800	93 (42)	117 (53)	140 (64)	163 (74)	187 (85)	210 (96)	233 (108)	257 (117)	280 (127)	303 (138)	327 (148)	350 (159)	373 (169)	397 (180)	420 (190)	443 (201)	467 (211)
2000	80 (36)	100 (45)	120 (55)	140 (64)	160 (73)	180 (82)	200 (91)	220 (100)	240 (109)	260 (118)	280 (127)	300 (136)	320 (145)	340 (154)	360 (163)	380 (172)	400 (181)
2200	67 (30)	83 (38)	100 (46)	117 (53)	133 (61)	150 (68)	167 (76)	183 (83)	200 (91)	217 (98)	233 (106)	250 (121)	267 (129)	283 (137)	300 (144)	317 (152)	333 (162)
2400	53 (24)	67 (30)	80 (36)	93 (42)	107 (48)	120 (55)	133 (61)	147 (67)	160 (73)	173 (79)	187 (85)	200 (91)	213 (98)	227 (104)	240 (110)	253 (117)	267 (123)
2600	40 (18)	50 (23)	60 (27)	70 (32)	80 (36)	90 (41)	100 (45)	110 (50)	120 (55)	130 (59)	140 (64)	150 (68)	160 (73)	170 (81)	180 (86)	190 (90)	200 (95)
2800	27 (12)	33 (15)	40 (18)	47 (21)	53 (24)	60 (27)	67 (30)	73 (33)	80 (36)	87 (39)	93 (42)	100 (45)	107 (48)	113 (51)	120 (54)	127 (57)	133 (60)
3000	13 (6)	17 (8)	20 (9)	23 (11)	27 (12)	30 (14)	33 (15)	37 (17)	40 (18)	43 (20)	47 (21)	50 (23)	53 (24)	57 (26)	60 (27)	63 (29)	67 (30)
3200	Ideal	Ideal	Ideal	Ideal	Ideal	Ideal	Ideal	Ideal	Ideal	Ideal	Ideal	Ideal	Ideal	Ideal	Ideal	Ideal	Ideal
3400	OK	OK	OK	OK	OK	OK	OK	OK	OK	OK	OK	OK	OK	OK	OK	OK	OK
3600+	Dilute	Dilute	Dilute	Dilute	Dilute	Dilute	Dilute	Dilute	Dilute	Dilute	Dilute	Dilute	Dilute	Dilute	Dilute	Dilute	Dilute

POUNDS and (Kg) OF STABILIZER (CYANURIC ACID) NEEDED FOR 80 PPM

Current Stabilizer Level (ppm)	Gallons and (Liters) of Pool/Spa water																
	8,000 (30,000)	10,000 (37,500)	12,000 (45,000)	14,000 (52,500)	16,000 (60,000)	18,000 (67,500)	20,000 (75,000)	22,000 (82,500)	24,000 (90,000)	26,000 (97,500)	28,000 (105,000)	30,000 (112,500)	32,000 (120,000)	34,000 (127,500)	36,000 (135,000)	38,000 (142,500)	40,000 (150,000)
0 ppm	5.3 (3.6)	6.7 (4.3)	8.0 (3.6)	9.4 (4.3)	10.7 (4.9)	12.0 (5.4)	13.4 (6.1)	14.7 (6.7)	16.0 (7.3)	17.3 (7.9)	18.7 (8.5)	20.0 (9.1)	21.3 (9.7)	22.7 (10.3)	24.0 (10.9)	25.3 (11.5)	26.7 (12.0)
10 ppm	4.7 (3.2)	5.8 (3.7)	7.0 (3.2)	8.2 (3.7)	9.4 (4.3)	10.5 (4.8)	11.7 (5.3)	12.9 (5.9)	14.0 (6.4)	15.2 (6.9)	16.4 (7.4)	17.2 (8.0)	18.7 (8.5)	19.8 (9.0)	21.0 (9.5)	22.2 (10.0)	23.3 (10.5)
20 ppm	4.0 (2.7)	5.0 (3.2)	6.0 (2.7)	7.0 (3.2)	8.0 (3.6)	9.0 (3.6)	10.0 (4.5)	11.0 (5.0)	12.0 (5.4)	13.0 (5.9)	14.0 (6.4)	15.0 (6.8)	16.0 (7.2)	17.0 (7.7)	18.0 (8.1)	19.0 (8.6)	20.0 (9.0)
30 ppm	3.3 (2.3)	4.2 (2.7)	5.0 (2.3)	5.9 (2.7)	6.7 (3.0)	7.5 (3.4)	8.4 (3.8)	9.2 (4.2)	10.0 (4.5)	10.8 (4.9)	11.7 (5.2)	12.5 (5.6)	13.3 (6.0)	14.2 (6.3)	15.0 (6.7)	15.8 (7.1)	16.7 (7.5)
40 ppm	2.7 (1.8)	3.3 (2.1)	4.0 (1.8)	4.7 (2.1)	5.4 (2.4)	6.0 (2.7)	6.7 (3.0)	7.4 (3.3)	8.0 (3.6)	8.7 (3.9)	9.3 (4.2)	10.0 (4.5)	10.7 (4.8)	11.3 (5.1)	12.0 (5.4)	12.7 (5.7)	13.3 (6.0)
50 ppm	2.0 (1.4)	2.5 (1.6)	3.0 (1.4)	3.5 (1.6)	4.0 (1.8)	4.5 (2.0)	5.0 (2.3)	5.5 (2.5)	6.0 (2.7)	6.5 (2.9)	7.0 (3.2)	7.5 (3.4)	8.0 (3.6)	8.5 (3.9)	9.0 (4.1)	9.5 (4.3)	10.0 (4.5)
60 ppm	1.3 (0.9)	1.7 (1.1)	2.0 (0.9)	2.3 (1.1)	2.7 (1.2)	3.0 (1.4)	3.3 (1.5)	3.7 (1.7)	4.0 (1.8)	4.3 (2.0)	4.7 (2.1)	5.0 (2.3)	5.3 (2.4)	5.7 (2.6)	6.0 (2.7)	6.3 (2.8)	6.7 (3.0)
70 ppm	0.7 (0.45)	0.8 (0.54)	1.0 (0.45)	1.2 (0.54)	1.4 (0.64)	1.5 (0.68)	1.8 (0.77)	1.8 (0.82)	2.0 (0.91)	2.2 (1.0)	2.3 (1.1)	2.5 (1.2)	2.7 (1.2)	2.8 (1.3)	3.0 (1.3)	3.2 (1.4)	3.3 (1.5)
80 ppm	0.0	0.0	0.0	0.0	0.0	0.0	0.0	0.0	0.0	0.0	0.0	0.0	0.0	0.0	0.0	0.0	0.0

Controls

Keypad Buttons

RUN/STOP: The Aqua Rite Pro will toggle back and forth between RUN and STOP with each push of the RUN/STOP button.

RUN: When in RUN mode, the Aqua Rite Pro will produce chlorine according to the desired output % or ORP setting (when AQL-CHEM is used) for the entire filtering/pumping cycle. The Aqua Rite Pro can only produce chlorine when RUN is selected and the filter pump is running.

STOP: When in STOP mode, the Aqua Rite Pro is prevented from energizing the electrolytic cell. In this position there is no chlorine generation. NOTE: To service any of the pool equipment or the Aqua Rite Pro, the power must be turned off at the circuit breaker.

SUPER CHLORINATE: (*if optional AQL-CHEM sensing is NOT used*) When you have an abnormally high bather load, a large amount of rain, a cloudy water condition, or any other condition which needs a large amount of purification to be introduced, SUPER CHLORINATE should be selected. This electronically “super chlorinates” (shocks) the water for a user selectable period of 1-96 hours (filter pump must be on during this time) or until the power has been turned off, whichever comes first. The Aqua Rite Pro will automatically revert back to the previous desired output % setting at the end of the super chlorinate period.

INFO: Push the INFO button to enter the Information Menu (see Information Menu).

SETTINGS: Push the SETTINGS button to enter the Settings Menu (see Settings Menu).

CURSORS (+, -, <, >): Use these buttons to scroll through submenus, make selections and adjust values.

Indicator LED's

RUN/STOP: When illuminated, the Aqua Rite Pro is in automatic mode and will produce chlorine based on the desired output % or ORP setting (when AQL-CHEM is used). When the LED is off, the Aqua Rite Pro has been manually turned off. It will not produce chlorine until RUN has been selected.

SUPER CHLORINATE: When illuminated, the Super Chlorinate feature is active.

CHECK SYSTEM: When Check System is illuminated, an error has occurred that requires attention. Refer to the Troubleshooting section of this manual for possible errors and solutions.

Information Menu

The Information Menu displays valuable system and pool information. The Aqua Rite Pro will default to displaying a portion of the Information Menu when no buttons have been pushed for 2 minutes. The unit will automatically scroll through several status displays. To access all of the Information Menu items, push the INFO button on the front panel. Advance through the various menu items using the "<" or ">" buttons. A list of the Information Menu items is shown below.

if ORP Auto Sensing is not used

Chlorinator 50%	+ - No function
	< > Move to previous/next menu item
Super Chlorinate 22:15 remaining	+ - No function
	< > Move to previous/next menu item

The Aqua Rite Pro desired output % is shown here. If Super Chlorinate is active, the display will show the time remaining until the Aqua Rite Pro will return to the desired output %. This menu is disabled if an AQL-CHEM is used and ORP Auto Sensing is enabled (see AQL-CHEM manual).

if AQL-CHEM is used

pH 7.5 (On)	+ - No function
ORP 700 mV (On)	< > Move to previous/next menu item

This display will be shown only if chemical sensing is enabled. This display shows both pH and ORP levels/status when chemistry sensing is enabled via the Chemistry Configuration Wizard (requires the use of AQL-CHEM Sensing Kit). The Aqua Rite Pro will refer to these levels to determine how much chlorine to generate (ORP) and how much CO₂ or acid to dispense (pH). Refer to the AQL-CHEM manual for specific information about these levels as well as the recommended ranges.

+23.45	+6.75A	+ - Press to switch chlorinator operation to opposite polarity (15 second delay)
84°F	3200PPM	< > Move to previous/next menu item

+/- 23.45V is the voltage applied to the chlorinator cell
+/-6.75A is the current (amps) through the cell
84°F is the water temperature at the cell
3200PPM is the "instant" salt level at this time

For the chlorinator to be operating, several conditions must exist: the filter pump must be running, the flow switch must be detecting flow, the chlorinator setting must be set greater than 0%, the water temperature at the cell must be between 50°F and 140°F, and the salt level must be within the operating range. If any of these conditions are not met, the chlorinator diagnostic display will tell you the reason. It's possible to have more than one reason, in which case after you rectify what was displayed the first time, a second display will appear.

If the current (amps) display is 0.00A, then the chlorinator is operating normally but is in the off part of its normal operating cycle. Simply press either the "+" or "-" key to start a new cycle.

The Aqua Rite Pro periodically reverses the polarity of the voltage applied to the cell in order to automatically clean off any calcium deposits that may have built up on the cell. It is important that you check the chlorinator operation in both polarities. To do this, press either the "+" or "-" buttons and the chlorinator will turn off, wait for 15 seconds and then turn on in the opposite polarity.

Salt Level
3200 PPM

- + - No function
- < > Move to previous/next menu item

This is the average "Salt Level" in the pool. This value is calculated over time and minimizes the effects of spikes or dips that may naturally occur.

Instant Salt
3200 PPM (+ = save)

- + Press to load the "Instant Salt" into the averaged salt display
- < > Move to previous/next menu item

The "Instant Salt" is calculated based on the voltage, current (amps), and water temperature at the cell at that instant. There are a number of reasons why instant and average salt readings may differ. Some of these include salt having just been added to the pool and not yet thoroughly mixed, calcium buildup on the cell, and cell aging.

Press the "+" button to enter the instant salt value into the average salt level. The average salt level will use this new value for its calculations.

Flow Switch
Flow

- + - No function
- < > Move to previous/next menu item

The current status of the flow switch is displayed. There is a short delay when transitioning from flow to no-flow and a longer delay on the transition from no-flow to flow. The delay time is displayed.

Main Software
Revision 2.40

- + - No function
- < > Move to previous/next menu item

Display Software
Revision 3.10

- + - No function
- < > Move to previous/next menu item

Chemistry Sense
Software r1.00

- + - No function
- < > Move to previous/next menu item

Available displays depend on configuration. These displays show the software revisions of various components.

Inspect Cell
hold + to reset

- + Press to reset
- < > Move to previous/next menu item

For optimum operation, you will need to inspect the Aqua Rite Pro chlorinator cell approximately every 3 months and clean the cell if necessary. The Aqua Rite Pro will automatically remind you and display "Inspect Cell, hold + to reset" as part of the rotating Information Menu. Clean the cell and then press the "+" button during the "Inspect Cell" display to reset the timer.

- | |
|--------------------------|
| Check System
Low Salt |
|--------------------------|

 +- Function depends on displayed menu item
 <> Move to next Check System condition or previous/next menu item

Refer to the Troubleshooting section for information about error conditions and possible causes.

Settings Menu

The Settings Menu is used to configure the Aqua Rite Pro and adjust various settings. Access this menu by pushing the Settings Menu button. Refer to the information below when setting system operating parameters.

- | |
|------------------------------------|
| Chlor. Config.
+ to view/change |
|------------------------------------|

 + Push to access Chlorinator option
 <> Move to next menu item
- | |
|-----------------------------|
| Body of Water Type
Pools |
|-----------------------------|

 +- Toggle between Pool and Spa
 <> Move to next menu item
- | |
|-----------------|
| Display
Salt |
|-----------------|

 +- Toggle between Salt (default) and Minerals
 <> Move to next configuration menu
- | |
|------------------------|
| Cell Type
T-CELL-15 |
|------------------------|

 +- Toggle between T-CELL-5 and T-CELL-15
 <> Move to next menu item

Body of Water Type

Select Pool or Spa. "Pool" should be selected for bodies of water over 1000 gallons. The Aqua Rite Pro will adjust its operation according to this selection.

Display

Allows for the display of salt (default) or mineral values.

Cell Type Selection

Make the proper selection based on the electrolytic cell that is used in your system. For pools up to 20,000 gallons, the T-CELL-5 is typically used. The T-CELL-15 is used for pools up to 40,000 gallons.

if AQL-CHEM is used

- | |
|--|
| Chemistry Config.
Wizard + to enter |
|--|

 + Push to access Chemistry Config. Wizard
 <> Move to previous/next menu item
- | |
|---------------------------|
| Sensing System
Enabled |
|---------------------------|

 +- Toggle between Enabled and Disabled (default)
 <> Move to next menu item

Requires use of the optional AQL-CHEM Sensing Kit. Following the steps of the Chemistry Config. Wizard will set up the AQL-CHEM to sense ORP and pH levels. The Aqua Rite Pro will generate the correct amount of chlorine to properly sanitize the pool based on the AQL-CHEM sensing function. Refer to the AQL-CHEM manual for more detailed information.

Display Light
On for 60 sec

- + - Toggle between Always On and On for 60 sec.
- <> Move to previous/next menu item

This function controls the backlight on the display. Select between "Always On" and "On for 60 seconds". If "On for 60 seconds" option is selected, then the backlight will automatically turn off 60 seconds after the last key is pressed and will stay off until next time a key is pressed.

Beeper
Enabled

- + - Toggle between Enabled (default) and Disabled Beeper
- <> Move to previous/next menu item

When "Enabled", the keypad will beep every time a key is pressed. If this audible indication is not desired, select "Disabled".

Reset Config. to
Default Press +

- + Initiate reset of all configuration parameters
- <> Move to previous/next menu item (config. not reset)

Are you sure?
+ to proceed

- + Reset all configuration parameters
- <> Move to previous/next menu item (config. not reset)

Config. reset
Confirmed

- <> Move to previous/next settings menu item

Use this function to erase all previous system configuration and reset all configuration parameters back to the factory default values. This function is NOT reversible--be careful

Operation

Assuming that the water chemical levels are in the recommended range, there are three factors that you can control which directly contribute to the amount of chlorine the Aqua Rite Pro will generate:

1. filter run time each day (hours)
2. the desired output % setting or ORP setting (when using AQL-CHEM)
3. the amount of salt in the pool

The filter pump timer should be set so that entire volume of pool water passes through the filter each day. For pools with high chlorine demand, the timer may have to be set longer to generate enough chlorine.

If optional AQL-CHEM sensing is NOT used. To find the optimum desired output % setting, start at approximately 50%. Test the chlorine level every few days and adjust the setting up or down accordingly. It usually takes 2-3 adjustments to find the ideal setting for your pool/spa and after that, it should only take minor, infrequent adjustments. Because the chlorine demand of the pool increases with temperature, most people find they have to adjust the desired output up at the peak of the summer and down during the colder periods.

The Aqua Rite Pro automatically stops generating when the pool water temperature drops below 50°F. This is usually not a problem because bacteria and algae stop growing at this temperature. You can override this low temperature cutoff by using the Super Chlorinate function for a day.

Prevent overchlorination during cold weather: Check chlorine levels periodically. Most pools require less chlorine during cold weather and the desired output % setting should be lowered accordingly.

Maintaining the Aqua Rite Pro System

To maintain maximum performance, it is recommended that you open and visually inspect the cell every 3 months or after cleaning your filter. The Aqua Rite Pro will remind you to do this by displaying the message "Inspect/Clean Cell" after approximately 500 hours of operation.

The Aqua Rite Pro electrolytic cell has a self cleaning feature incorporated into the electronic control's logic. In most cases this self cleaning action will keep the cell working at optimum efficiency. In areas where water is hard (high mineral content) and in pools where the water chemistry has been allowed to get "out of balance", the cell may require periodic cleaning.

Servicing and Cleaning the Aqua Rite Pro cell

Turn off power to the Aqua Rite Pro before removing the electrolytic cell. Once removed, look inside the cell and inspect for scale formation (light colored crusty or flaky deposits) on the plates and for any debris which has passed through the filter and caught on the plates. If no deposits are visible, reinstall. If deposits are seen, use a high pressure garden hose and try to flush the scale off. If this is not successful, use a plastic or wood tool (do not use metal as this will scratch the coating off the plates) and scrape deposits off of plates. Note that a buildup on the cell indicates that there is an unusually high calcium level in the pool (old pool water is usually the cause). If this is not corrected, you may have to periodically clean the cell. The simplest way to avoid this is to bring the pool chemistry to the recommended levels as specified.

Mild Acid Washing: Use only in severe cases where flushing and scraping will not remove the majority of deposits. To acid wash, turn off power to Aqua Rite Pro. Remove cell from piping. In a clean plastic container, mix a 4:1 solution of water to muriatic acid (one gallon of water to one quart of muriatic acid). **ALWAYS ADD ACID TO WATER - NEVER ADD WATER TO ACID.** Be sure to wear rubber gloves and appropriate eye protection. The level of the solution in the container should just reach the top of the cell so that the wire harness compartment is NOT submerged. It may be helpful to coil the wiring before immersing the cell. The cell should soak for a few minutes and then rinse with a high pressure garden hose. If any deposits are still visible, repeat soaking and rinsing. Replace cell and inspect again periodically.

Winterizing

The Aqua Rite Pro electrolytic cell and flow detection switch will be damaged by freezing water just as your pool plumbing would. In areas of the country which experience severe or extended periods of freezing temperatures, be sure to drain all water from the pump, filter, and supply and return lines before any freezing conditions occur. The electronic control is capable of withstanding any winter weather and should not be removed.

Spring Start-up

DO NOT turn the Aqua Rite Pro on, until the pool water chemistry has been brought to the proper levels. This information can be found on page 1.

INSTALLATION

Installation must be performed in accordance with Local and NEC codes.

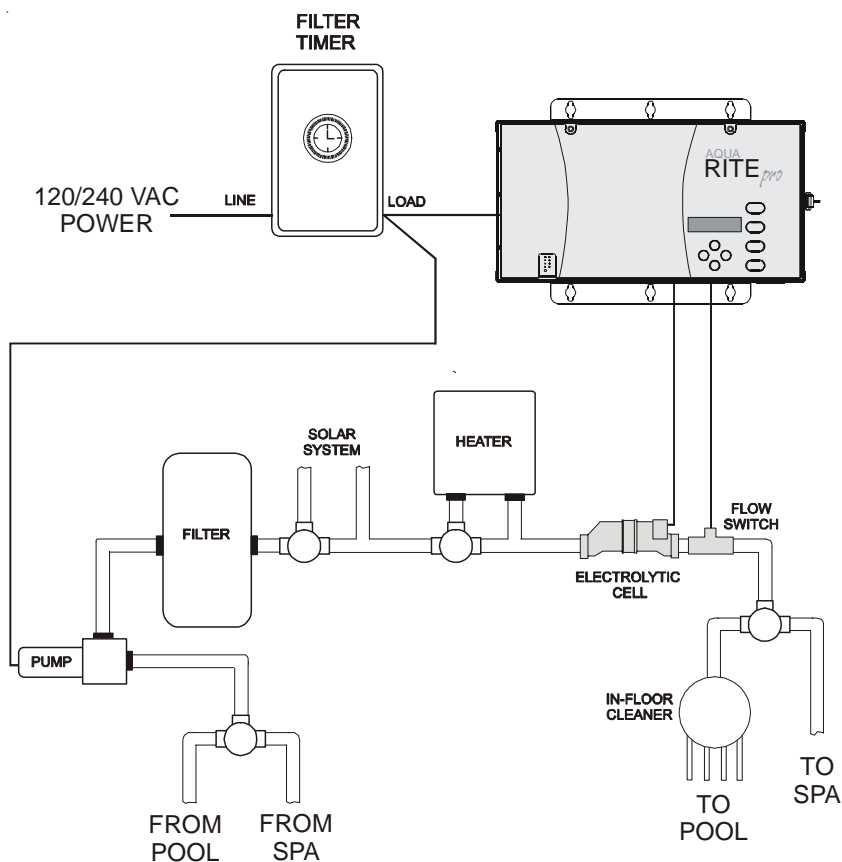

Preparing Pool/Spa Water

Refer to page 1 for recommended chemical levels. The pool's chemistry must be balanced **BEFORE** activating the Aqua Rite Pro. **NOTE:** If the pool does not have new water, add 1 quart (1 liter) of metal remover and 1 quart (1 liter) of non-copper based algaecide to the pool, per manufacturer's instructions. This ensures a quick, troublefree transfer to the Aqua Rite Pro system.

Mounting the Aqua Rite Pro Control

The Aqua Rite Pro is contained in a raintight enclosure that is suitable for outdoor mounting. The control must be mounted a minimum of 5 ft. (1.5 meters) horizontal distance (or more, if local codes require) from the pool/spa.

The control is designed to mount horizontally on a flat surface with the knockouts facing downward. Because the enclosure also acts as a heat sink (disperses heat from inside the box), it is important not to block the four sides of the control. Do not mount Aqua Rite Pro inside a panel or tight enclosed area.

If an AQL-CHEM kit will be used, take into consideration the space necessary for mounting the unit as well as running the plumbing lines from the AQL-CHEM's probe cell to the pool plumbing. Refer to the AQL-CHEM manual for specific mounting instructions.

Plumbing

Ensure that the Aqua Rite Pro installation does not constitute a cross connection with the local potable water supply. Consult local plumbing codes.

The flow switch and cell should be plumbed in the return line to the pool/spa. The preferred installation is after (downstream) all the pool equipment (filter, heater, solar, etc.). The electrolytic cell and flow switch tee fitting are designed to be plumbed into 2" (51mm) PVC pipe. Adapters (not included) can be used for systems with 1½" (38 mm) plumbing.

For proper plumbing, refer to the overview diagram on page 13. Alternate configurations #1 shows the flow switch can also be in front of the cell. Configurations #2 and #3 allow for chlorination of both the pool and spa during spa spillover operation, but prevent overchlorination of the spa during "spa only" operation. Never use configuration #4.

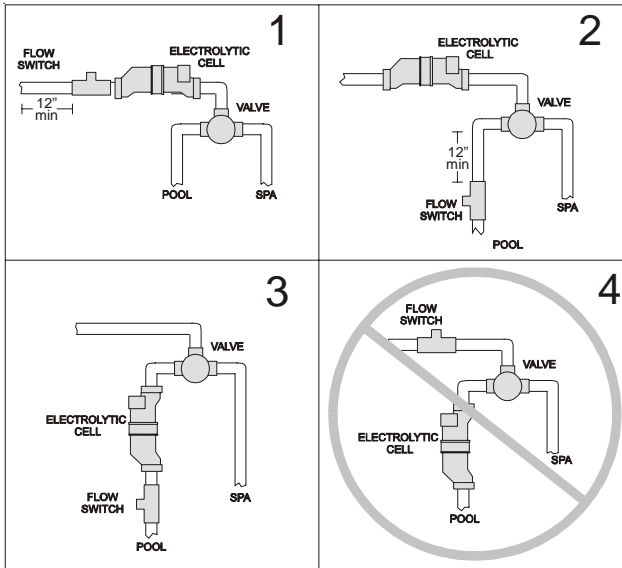

Flow Switch: **IMPORTANT:** There must be at least a **12" (25cm)** straight pipe run before (upstream) the flow switch. If the switch is plumbed after the cell, the cell can be counted as the 12" (25cm) of straight pipe. To ensure proper operation, verify that the arrow on the flow switch (located on top of gray hex) points in the direction of water flow.

Electrolytic Cell: Install using the unions provided. Tighten unions **BY HAND** for a watertight seal. For pool/spa combination systems with spillover, use configurations #2 or #3 above to allow chlorination of both the pool and spa during spillover but preventing overchlorination when operating the spa only.

Wiring

Power must be shut off at the circuit breaker before performing any wiring. Be sure to follow Local and NEC electrical codes. To provide safe operation, the Aqua Rite Pro must be properly grounded and bonded.

Input Power:

Wire the Aqua Rite Pro to the **LOAD SIDE** of the filter pump timer. It is very important that the Aqua Rite Pro is powered **only** when the pump is running. **Note that this circuit must be protected by a Ground Fault Circuit Breaker (GFCB).**

Refer to the wiring label on the Aqua Rite Pro as well as the diagram below to determine correct wiring connections. The Aqua Rite Pro is shipped from the factory with the configuration jumpers in 240VAC position. If using 120VAC, move the jumpers as shown below. **IMPORTANT:** If a dispensing device will be used (page 17), it must be powered by the same input voltage as the Aqua Rite Pro.

For Canadian models, the Aqua Rite Pro shall be connected to a circuit protected by a class A ground fault interrupter. Be sure to connect the ground wire to the green ground screw terminal located on the bottom of the enclosure.

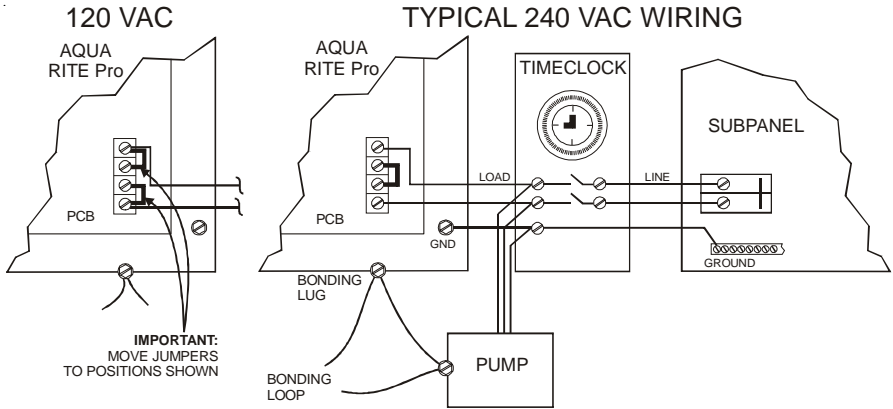

Note: Wire the pump directly to the timeclock--do not use the Aqua Rite Pro as a junction box.

Bonding:

A lug used for bonding is attached to the bottom of the Aqua Rite Pro enclosure (two lugs are provided for Canadian models). The Aqua Rite Pro must be bonded with an 8 AWG copper wire (6 AWG Canada) to the pool bonding system. Refer to the diagram below.

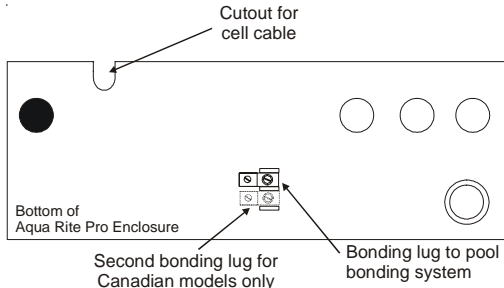

Electrolytic Cell and Flow Switch:

The electrolytic cell and flow switch cables are terminated with connectors which plug into the Aqua Rite Pro for easy attachment and removal. The door of the Aqua Rite Pro must be open and the front panel removed to access the cell cable and flow switch connectors. Route the flow switch cable through one of the knockouts. A cutout in the enclosure is provided for the cell cable. The diagram below shows the location of these connections.

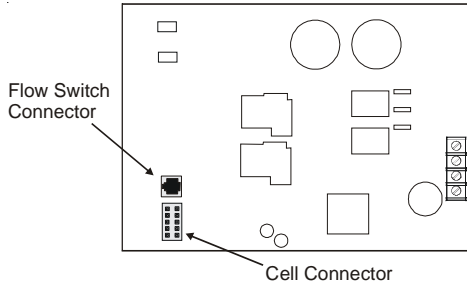

Optional AQL-CHEM Chemistry Kit

Plug the connector from the AQL-CHEM into the designated connector on the Aqua Rite Pro PCB as shown below. For detailed installation and operation information, refer to the AQL-CHEM instructions.

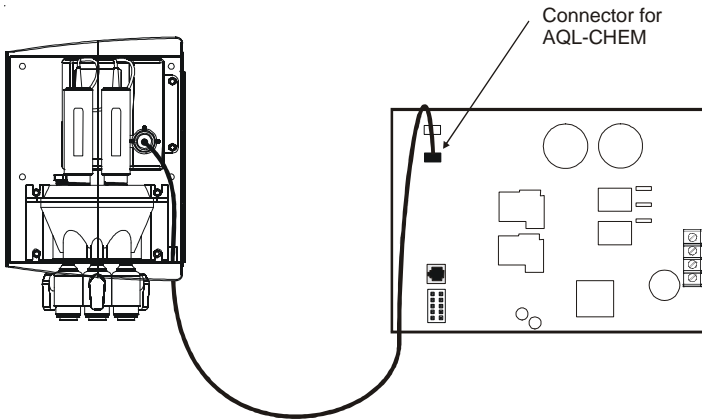

Goldline Aqua Rite Chlorinator

The Aqua Rite Pro can control one or more Goldline Aqua Rite chlorinators when additional sanitizing capacity is required. A 4 wire connection is used to communicate to the Aqua Rite(s) and can be wired up to 500' apart. Any outdoor rated 4 conductor cable can be used. Refer to the wiring diagram below and on the following page for proper wiring connection to the Aqua Rite. **NOTE:** There must be only 1 "primary" unit. All other Aqua Rite units must be configured as "secondary".

The Aqua Rite(s) power input must be wired to the **LOAD SIDE** of the filter pump timer (the same as the Aqua Rite Pro).

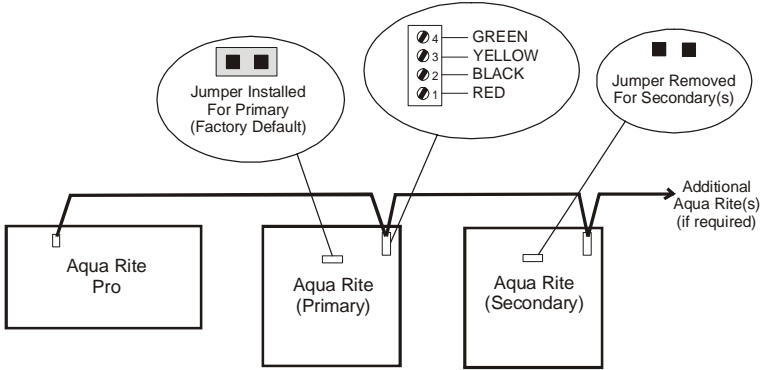

NOTE: Primary/Secondary jumper is located underneath small circuit board.

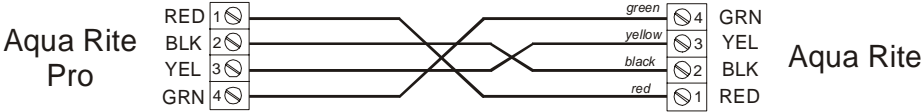

Optional pH Dispense Wiring

Requires the use of a Goldline AQL-CHEM sensing device and an AQL-CHEM2, AQL-CHEM2-240 or other pH dispensing device requiring 120VAC or 240VAC on/off control. A screw terminal block located on the enclosure surface below the transformer is provided for connection to an AQL-CHEM2, AQL-CHEM2-240 or other pH related dispensing device (peristaltic pumps, solenoid valves, etc.). After properly installing and configuring the AQL-CHEM and the pH dispensing device, the Aqua Rite Pro will turn on the dispensing device when pH correction is required.

IMPORTANT: The dispensing device must be powered by the same voltage used to power the Aqua Rite Pro. Configure the output voltage to the pH device by moving the wiring connections on the mainboard as shown on page 18.

Example: If an AQL-CHEM2-240 (240VAC) will be used, the Aqua Rite Pro must be powered by 240VAC. Connect the 240VAC pigtail supplied with the AQL-CHEM to the Aqua Rite Pro's terminal block as shown in the diagram. The AQL-CHEM2-240 will then plug into the pigtail's 240VAC receptacle. Refer to the AQL-CHEM manual for more detailed information.

240VAC pH Dispensing Device (Factory Default)

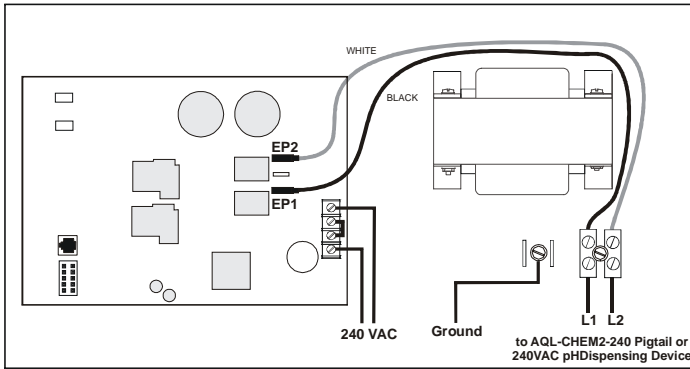

120VAC pH Dispensing Device

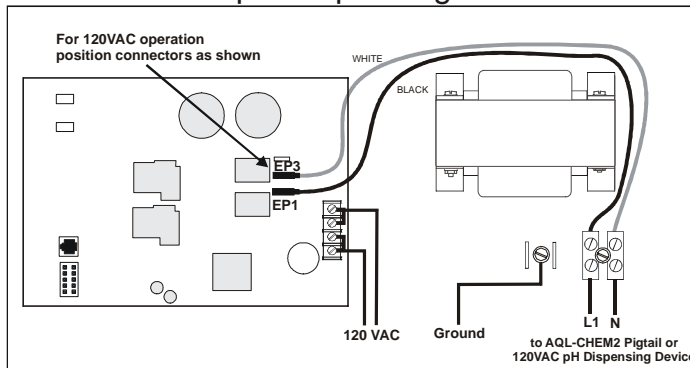

Troubleshooting Information

Check System Indicator

The “CHECK SYSTEM” LED will alert you when the Aqua Rite Pro detects any of the following conditions that are abnormal and require attention for optimal operation of your pool. Press “<” or “>” to view all of the existing “Check System” conditions.

- **Inspect Cell** -- for optimum operation, you will need to inspect the Aqua Rite Pro chlorinator cell approximately every 3 months and clean the cell if necessary. The Aqua Rite Pro will automatically remind you when it is time and display “Inspect Cell, + to reset” as part of the rotating Default Menu. Clean the cell (see instructions, page 12) and then press the “+” button during the “Inspect Cell” display to reset the timer.
- **Low Salt/Minerals or Very Low Salt/Minerals** -- when the salt is too low the Aqua Rite Pro will generate less chlorine and the life of the cell is degraded. Check the cell and clean if necessary before adding salt.

- **High Salt/Amps/Minerals** -- the Aqua Rite Pro will stop generating chlorine under certain high salt conditions in order to protect the internal electronics from damage. The only way to lower the salt level is to partially drain the pool and add fresh water.
- **Chlorinator Cell Sensor** -- the cell sensor is either an open or short circuit.
- **Low Volts** -- if the chlorinator cell voltage is too low.
- **No Cell Power** -- if no chlorinator cell power is detected on the printed circuit board.
- **Check Flow Switch** -- if the flow switch input is invalid.
- **Cell Power Error** -- if a chlorinator cell power error is detected on the printed circuit board.
- **Cell Missing** -- if the chlorinator is enabled but no cell is detected.
- **CSM Comm Error:** -- If Chemistry Sensing is enabled and the Chemistry Sense Module (CSM) is not responding.
- **pH Probe Error** -- If the CSM indicates that there is a problem with the pH probe.
- **pH Low - Check Feeder** -- If a pH level of 6.9 or less is detected, check the feeder for proper operation
- **pH High - Check Feeder** -- If a pH level of 8.1 or higher is detected, check the chemical supply and the feeder for proper operation
- **pH Timeout - Check Feeder** -- If the unit has been dispensing for more than the selected timeout without reaching the desired level. Check the chemical supply and the feeder. If both are OK, the timeout may need to be increased. Press the “+” button to reset the alarm and resume dispensing.
- **pH Calibration Error** -- When using the pH Calibration Wizard and the entered test result was different from the measured pH level by ± 1.0 or more. The pH probe may need to be cleaned or replaced.
- **ORP Probe Error** -- If the CSM indicates that there is a problem with the ORP probe.
- **ORP Low - Check Chlor** -- If an ORP level of 350mV or less is detected. Check the chlorinator for proper operation.
- **ORP High - Check Chlor** -- If an ORP level of 950mV or higher is detected. Check the chlorinator for proper operation.
- **ORP High - Chlor Off** -- If an ORP level of 950mV or higher is detected and the chlorine feed mode is ORP Auto Sensing, the chlorinator has been turned off. Check the chlorinator for proper operation.
- **ORP Timeout -Chlor Off** -- If the unit has been chlorinating for more than the selected sanitizer timeout without reaching the desired level, the chlorinator has been turned off. Press the “+” button to reset the alarm and resume chlorination.
- **Ambient Sensor** -- If the internal (ambient) sensor is either open or short circuit.

LIMITED WARRANTY Goldline warrants its Aqua Rite, Aqua Rite Pro, Aqua Trol, Aqua Logic and Pro Logic products (products with Goldline part numbers starting with AQ-RITE-, AQ-RT-PRO, AQ-TROL-, AQ-LOGIC-, AQL-P-, AQL-PS-, AQL-CL-, PL-P-, PL-PS-, and HPC-2) to be free from defects in material or workmanship, under normal use and service:

For **three years** from the date of the initial system installation on private, residential swimming pools within the USA or Canada and **one year** from the date of initial system installation on commercial installations, installations outside of the USA or Canada and for any replacement parts or accessory products, provided they are installed in accordance with the Goldline installation instructions and specifications provided with the product. If written proof of the date of the initial system installation is not provided to Goldline, the manufacturing datecode on the Aqua Rite, Aqua Rite Pro, Aqua Trol, Aqua Logic and Pro Logic electronics unit will be the sole determinant of the date of the initial system installation.

For residential installations in USA or Canada: If a product is defective in workmanship or materials and is removed and returned freight prepaid within three (3) years after the date of the initial system installation, Goldline will, at its option, either repair or replace the defective product and return it freight prepaid.

For commercial installations, installations outside the USA and Canada, and accessory products and replacement parts: If a product is defective in workmanship or materials and is removed and returned freight prepaid within one (1) year after the date of the initial system installation, Goldline will, at its option, either repair or replace the defective product and return it freight prepaid.

Contact any Goldline dealer or contact Goldline at 61 Whitecap Drive, North Kingstown, RI 02852 for warranty service. The costs incurred in removal and/or reinstallation of the product are NOT covered under this warranty. Some states do not allow limitations on how long an implied warranty lasts, so the above limitation may not apply to you.

WARRANTY EXCLUSIONS:

1. Material supplied or workmanship performed by others in process of installation.
2. Damage resulting from improper installation including installation on pools larger than the product rating.
3. Problems resulting from failure to operate the product(s) in accordance with the recommended instructions contained in product's owners manual(s).
4. Problems resulting from failure to maintain pool water chemistry in accordance with the recommendations in the owners manual(s).
5. Problems resulting from tampering, accident, abuse, negligence, unauthorized repairs or alternations, fire, flood, lightning, freezing, external water, degradation of natural stone used in or immediately adjacent to a pool or spa, war or acts of God.

DISCLAIMER. THE EXPRESS LIMITED WARRANTY ABOVE CONSTITUTES THE ENTIRE WARRANTY OF GOLDLINE WITH RESPECT TO ITS POOL AUTOMATION AND CHLORINATION PRODUCTS AND IS IN LIEU OF ALL OTHER WARRANTIES, EXPRESSED OR IMPLIED, INCLUDING WARRANTIES OF MERCHANTABILITY OR FITNESS FOR A PARTICULAR PURPOSE. THIS WARRANTY GIVES YOU SPECIFIC LEGAL RIGHTS, AND YOU MAY ALSO HAVE OTHER RIGHTS WHICH VARY FROM STATE TO STATE. IN NO EVENT SHALL GOLDLINE BE RESPONSIBLE FOR ANY CONSEQUENTIAL, SPECIAL OR INCIDENTAL DAMAGES OF ANY NATURE WHATSOEVER, INCLUDING, BUT NOT LIMITED TO, PERSONAL INJURY, PROPERTY DAMAGE, DAMAGE TO OR LOSS OF EQUIPMENT, LOST PROFITS OR REVENUE, COSTS OF RENTING REPLACEMENTS, AND OTHER ADDITIONAL EXPENSES, EVEN IF THE SELLER HAD BEEN ADVISED OF THE POSSIBILITY OF SUCH DAMAGES. SOME STATES DO NOT ALLOW THE EXCLUSION OF LIMITATION OF INCIDENTAL OR CONSEQUENTIAL DAMAGES, SO THE ABOVE LIMITATION OR EXCLUSION MAY NOT APPLY TO YOU.

NO WHOLESALE, AGENT, DEALER, CONTRACTOR OR OTHER PERSON IS AUTHORIZED TO GIVE ANY WARRANTY ON BEHALF OF GOLDLINE.

THIS WARRANTY IS VOID IF THE PRODUCT HAS BEEN ALTERED IN ANY WAY AFTER LEAVING THE FACTORY.

ELECTROLYTIC CHLORINE GENERATOR BASIC POOL MAINTENANCE REQUIREMENTS

	TEST	IDEAL RANGE	ADJUSTMENT REQUIRED
WEEKLY	Free Chlorine	1.0 - 3.0 ppm	Raise desired output % to increase, lower desired output % to decrease -OR- increase or decrease pump filtration time.
	pH	7.2 - 7.6	Too high - add muriatic acid Too low - add soda ash.
MONTHLY	Alkalinity	80 - 120 ppm	Add baking soda to increase. Add acid as required to decrease.
	Salt	2700 - 3400 ppm	Add salt as required to increase.
QUARTERLY	Stabilizer	60 - 80 ppm	Add cyanuric acid to increase.
	Calcium	200 - 400 ppm	Add calcium to increase. Drain and add water to decrease.
	Electrolytic Cell	inspect & clean	Refer to section in manual.

Questions?

Refer to www.goldlinecontrols.com for latest manual revisions, additional information and helpful service.